

Contents

Product Overview	2
Display Introduction	2
Product and Accessories	2
Product Connection	4
Driver and Setting	6
Install Driver	6
Driver Interface Preview	17
Pen Display Setting	19
Digital Pen Setting	22
Driver Setting	31
Digital Pen Basic Operation	36
Specifications	40
Troubleshooting Solutions	41

Product Overview

Display Introduction

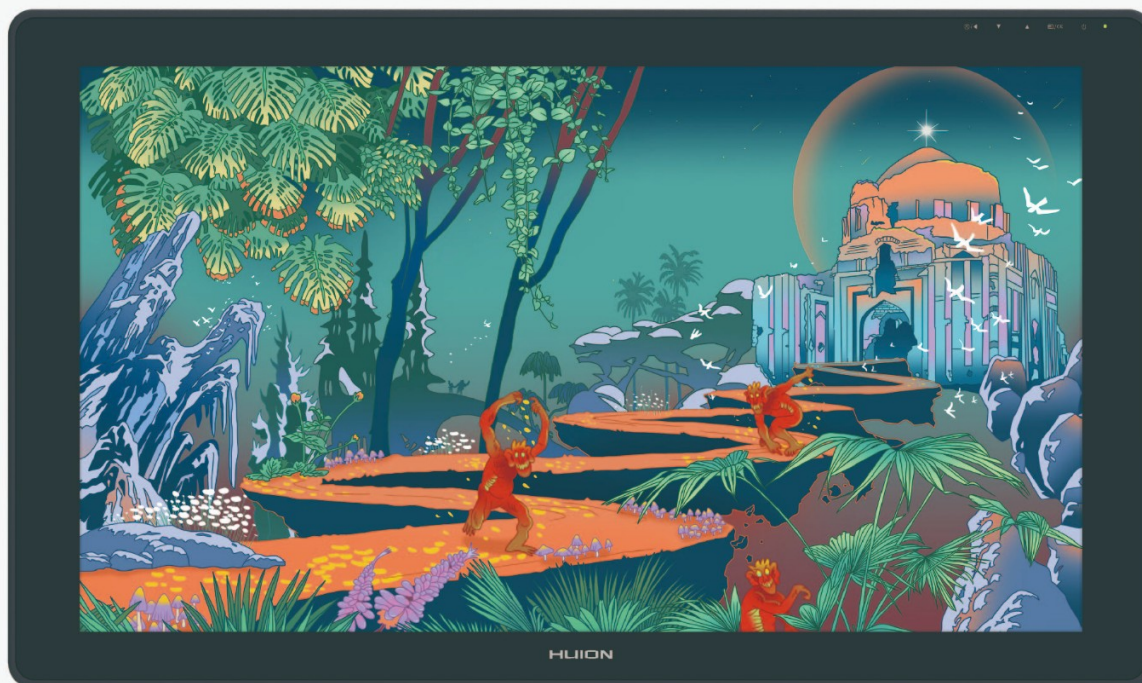

Thanks for choosing HUIION KAMVAS 24 creative pen display. This is a new generation of professional drawing display, which can greatly improve your work efficiency of painting and creation, and full of fun. You can freely painting and writing, depicting different lines and colors, just as the pen writes on the paper, which brings you a real shock experience. To give you a better understanding and using of your tablet, please read this user manual carefully. The user manual only shows the information under Windows, unless otherwise specified, this information applies to both Windows and Mac systems.

Note: The pictures in the User Manual are for reference only.

Product and Accessories

Product Overview

Please see the detailed product introduction.

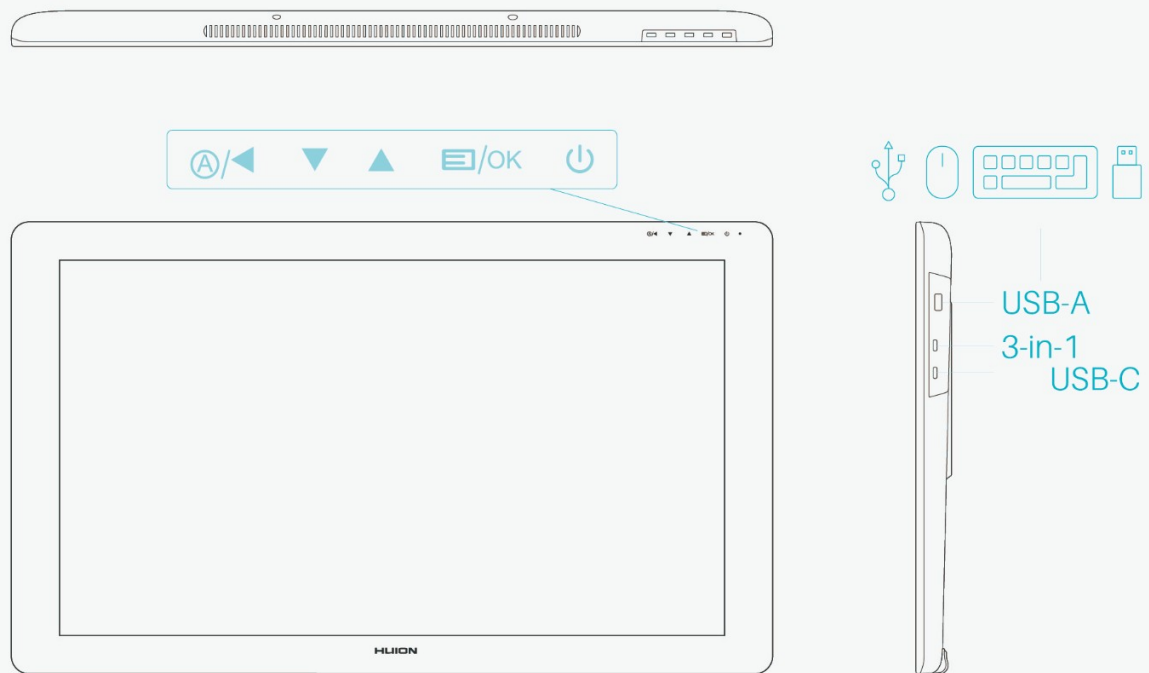

Accessories

After unboxing your package, make sure that you have the following items:

- Pen Display*1
- Battery-free Pen*1
- Pen Holder*1
- Replacement Nibs(Inside the Pen Holder)*10
- 3-in-1 Cable*1
- Power Cable*1
- Power Adapter*1
- Quick Start Guide*1
- Cleaning Cloth*1

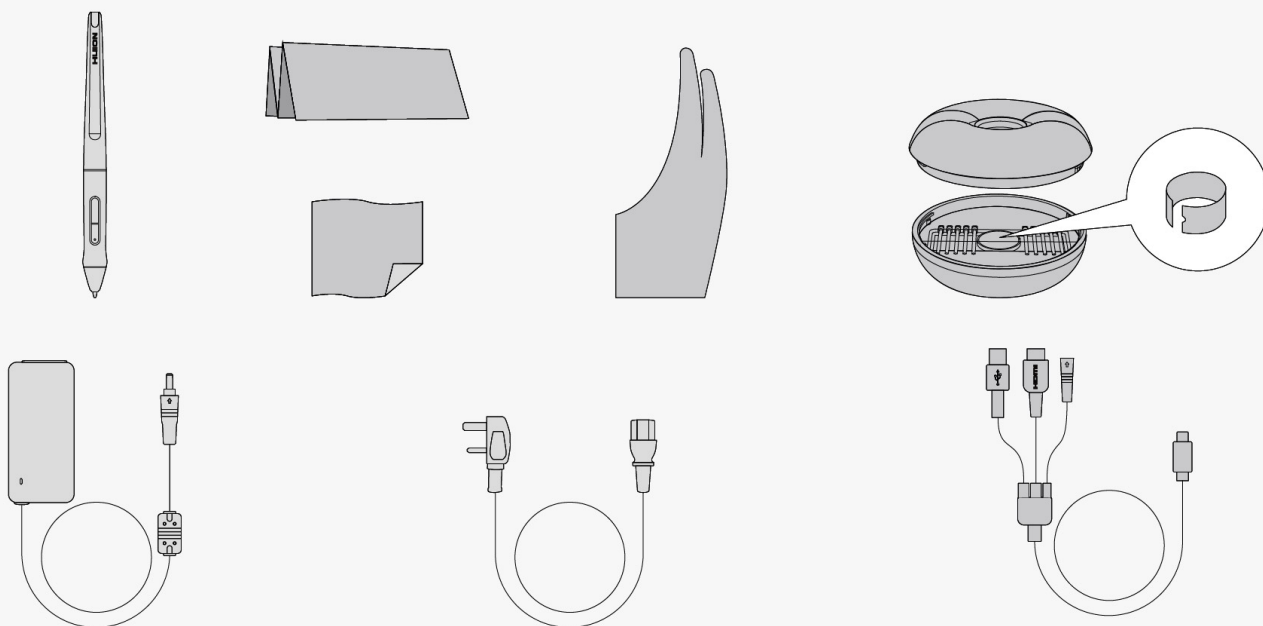

Product Connection

The display supports the connection of a computer and Android device, please refer to the following connection method.

Power Indicator Light

When the pen display is connected, you can look at the color of the indicator light to identify the status of the pen display.

Status Indication	Color of the IndicatorLight
The power is on, but there is no video signal input.	Red
The power is on, and there is video signal input.	Green
Sleeping	Red

* /OK

Press the key to call out the OSD Menu and change the settings of the menu via 4 keys (listed on the table below) on your pen display.

- /OK press the key to open the OSD menu before we access the menu, and it can function as a confirmation key to access the menu.
- ▲ Press the key to move upwards or rightwards to switch between options after we access the OSD menu.
 - ▼ Press the key to move downwards or leftwards to switch between options after we access the OSD menu.

A/◀ press the key to return to a previous menu after we access the OSD menu.

3-in-1 Type-C Cable

Connect the pen display to your computer with 3-in-1 Cable.

- ① Connect the display to your computer with 3-in-1 cable;
- ② Connect the power adapter to the power cable.

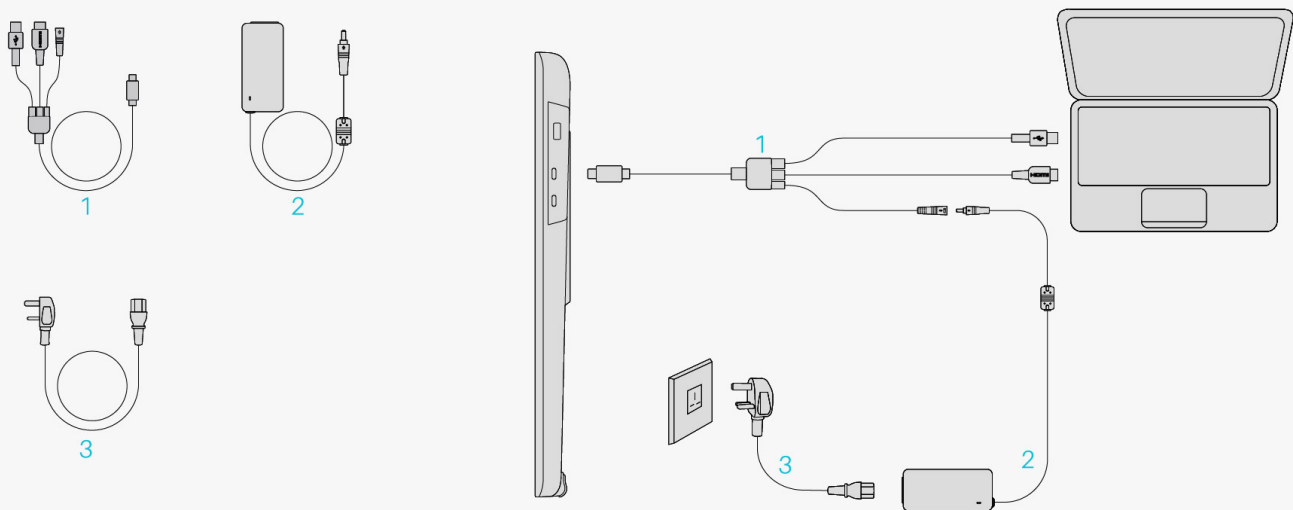

USB-C to USB-C Cable

Connect the display to your computer or Android device with USB-C to USB-C cable.

- ① Connect the display to your computer or Android device with USB-C to USB-C cable.
- ② Connect the power adapter to the power cable.

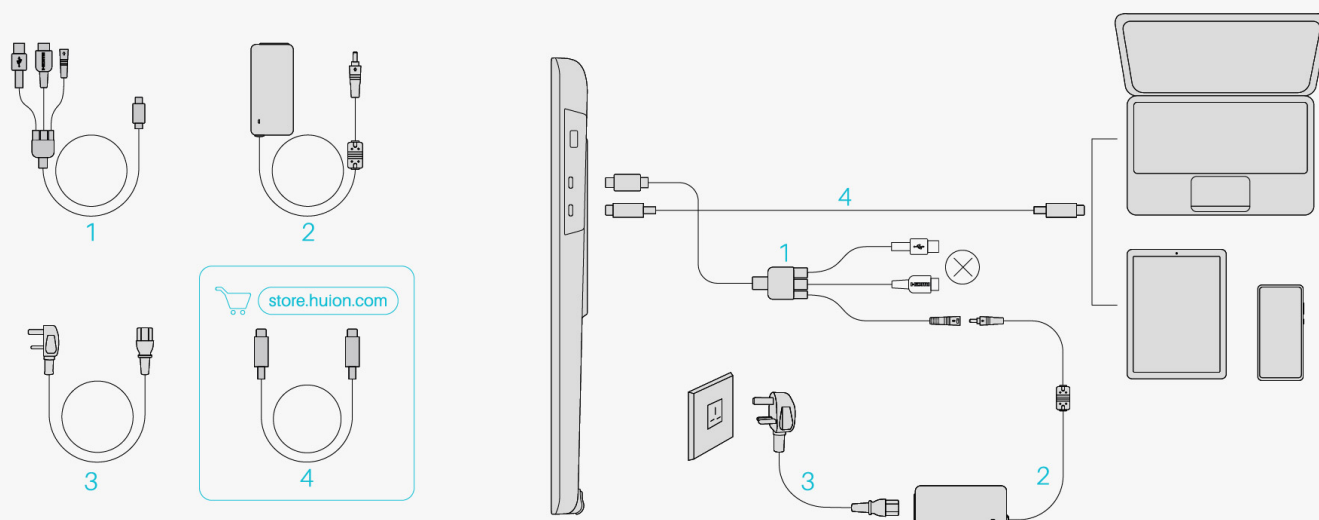

Driver and Setting

Install Driver

How to Install and Uninstall the Drivers on Windows/Mac Device

Notice:

1. Before installing driver, please close all graphic software and antivirus program.
2. If you have installed other pen tablet driver, please uninstall it before you install this driver.
3. Please make sure your computer OS are as following: Windows 7 or later, macOS 10.12 or later.
4. Run the tablet driver program and complete the installation according to the instruction.

After the download is successful, double-click to open the driver, Connect the device to your computer.

If the connection fails, please reconnect the computer to the device, or restart the driver or computer.

Here are the step-by-step instructions for installing the driver:

1. Please choose the correct driver for your device from our website: [Driver-Kamvas 24](#)
2. Click Driver-Inspiroy Giano to download it.
3. Follow the instructions to complete the installation.



Device Disconnected

[Device connected yet not recognized?](#)

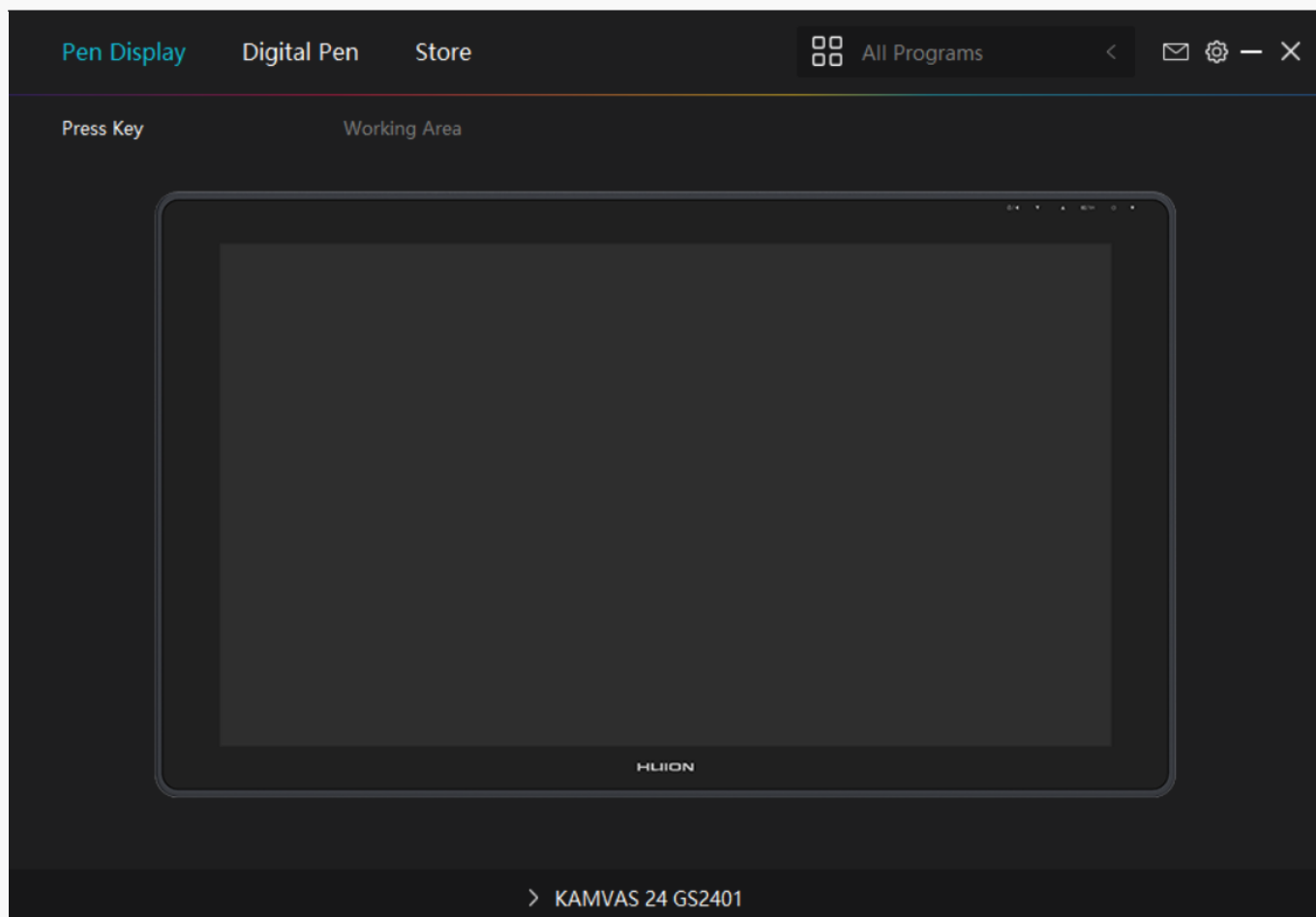

How to Install and Uninstall the Drivers on Linux Devices

Notice:

1. Please remember to close the command window and reboot your Linux device after installing the driver, or the driver will not be useful. After rebooting the device, you can access the system main menu to find the Huion Tablet driver and then open it to finish some settings.
2. If you are running Linux operating system on VMware, you must use the VMware Workstation Pro version. And the Play version of VMware Workstation doesn't support the Huion Tablet driver.
3. Some versions of the Ubuntu operating system don't support using more than one monitor simultaneously. And we recommend you upgrade your system to 20.04 LTS or later if you want to use a Huion painting device on multiple display screens simultaneously smoothly.

Huion Tablet Driver installation packages in 2 different formats are available for Linux devices:

- tar.xz (file format)

· deb (file format)

Here are the step-by-step instructions for installing the driver packages in different file formats respectively:

1. Instructions for installing the driver package file in tar.xz format.

Linux operating systems supported:

Ubuntu

Steps to Install:

1. Extract the contents of the driver file, huiontablet_XXXX.tar.xz, into a folder.

2. Open the command window in the folder.

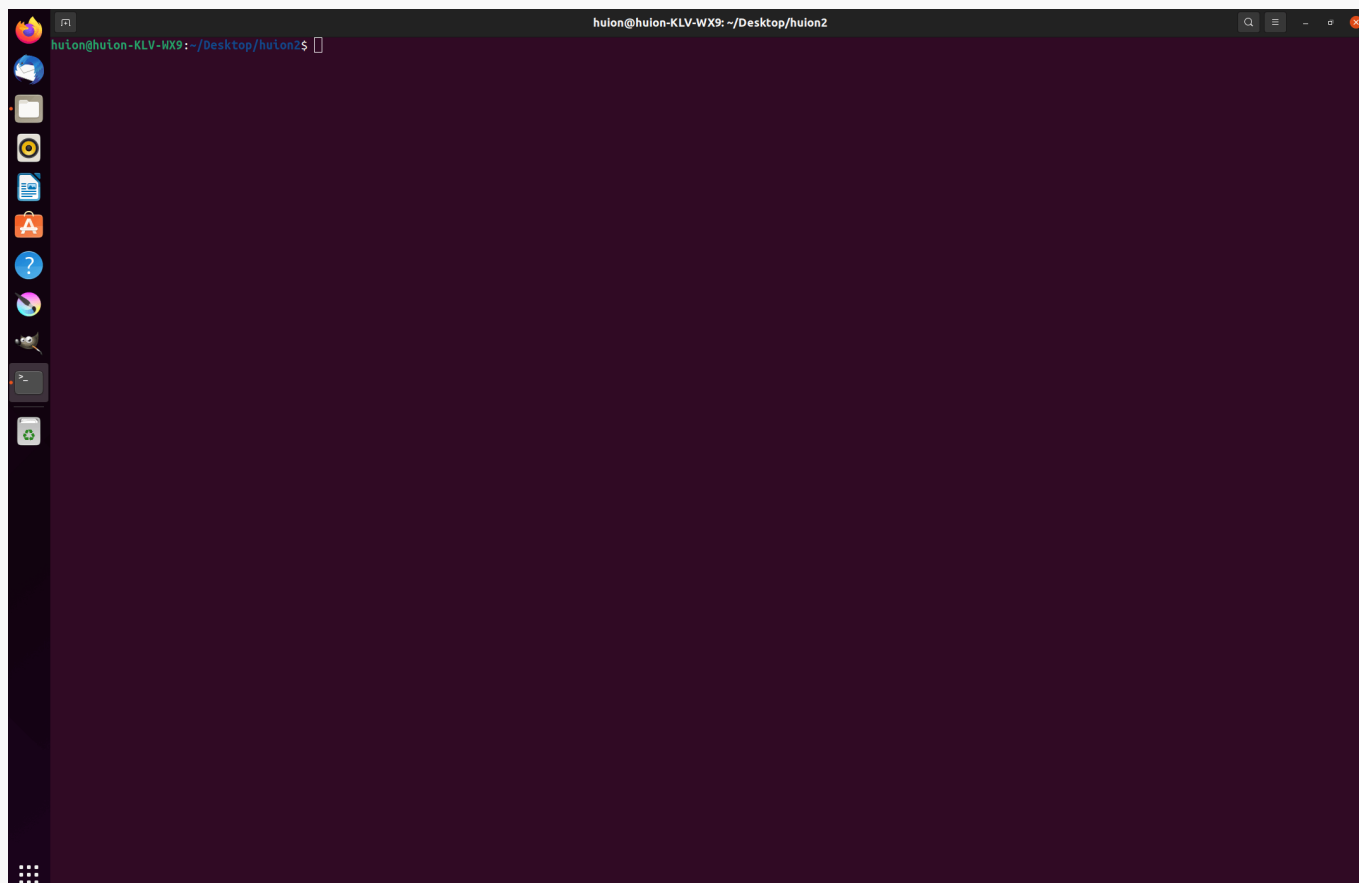

3. Input the following command: "sudo sh install.sh", and press the enter key on the keyboard to make your Linux device execute it.

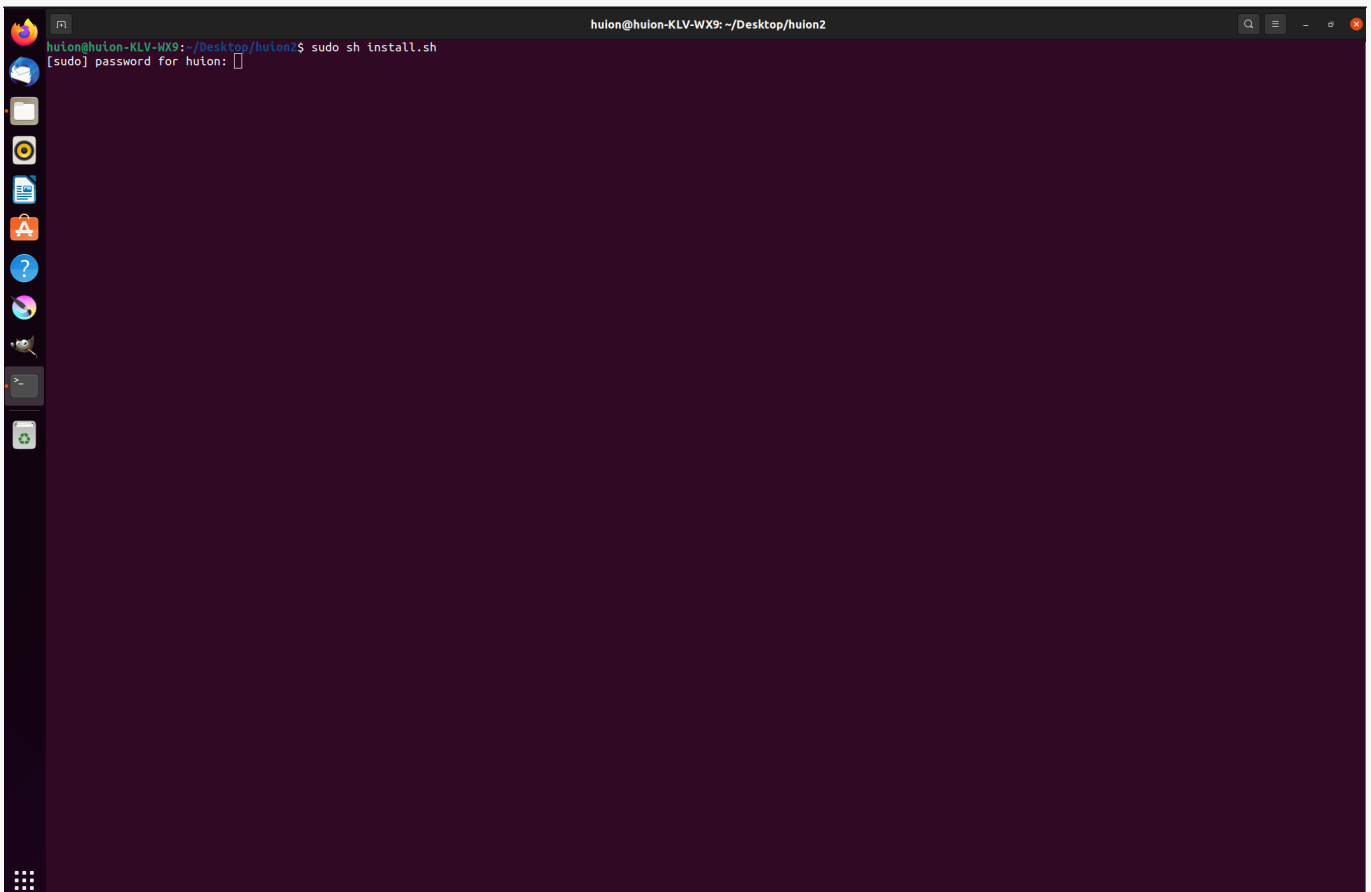

4. Enter the user password to complete the installation.

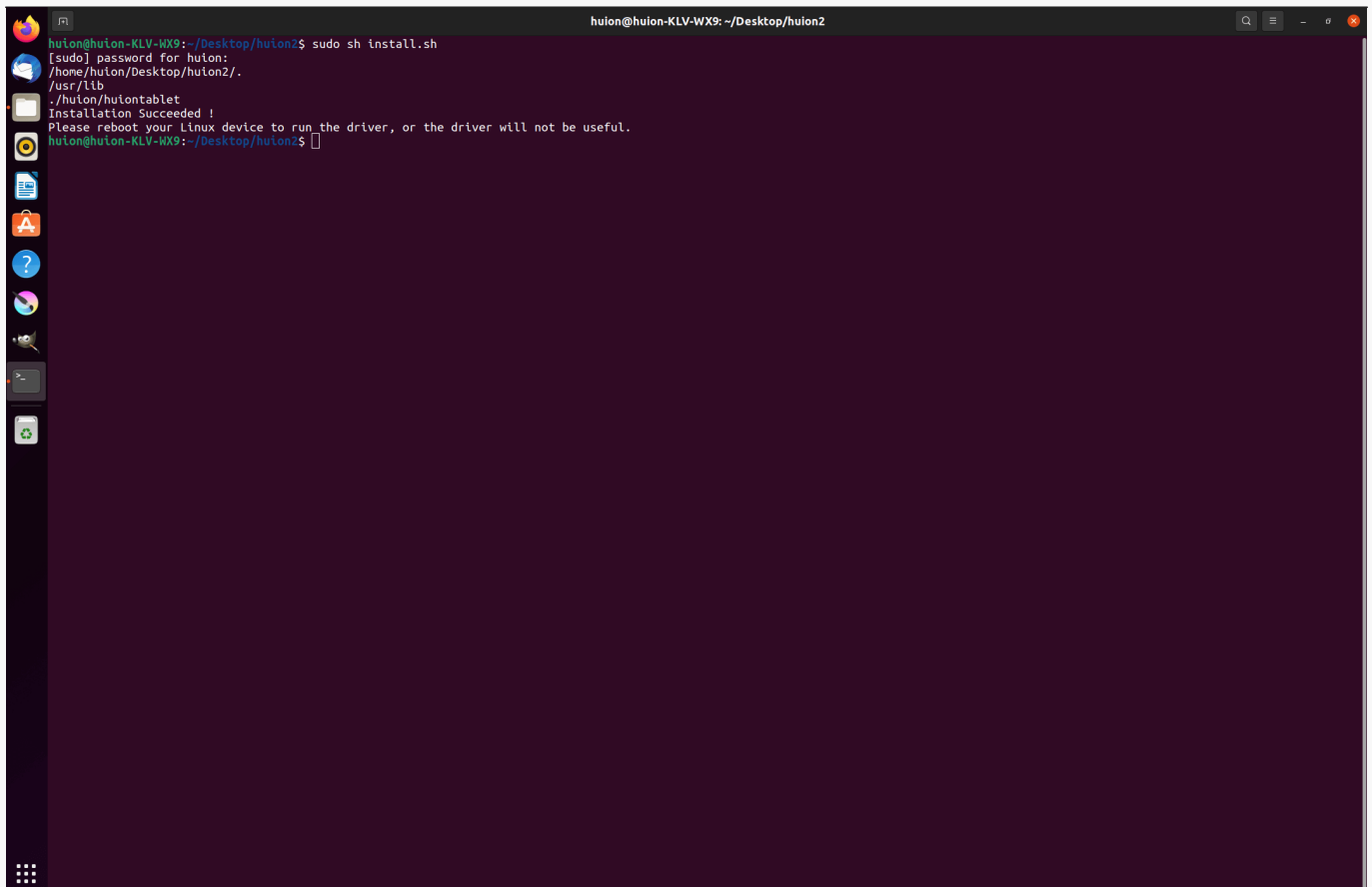

```
huion@huion-KLV-WX9: ~/Desktop/huion2
huion@huion-KLV-WX9:~/Desktop/huion2$ sudo sh install.sh
[sudo] password for huion:
/home/huion/Desktop/huion2/.
/usr/lib
./huion/huiontablet
Installation Succeeded !
Please reboot your Linux device to run the driver, or the driver will not be useful.
huion@huion-KLV-WX9:~/Desktop/huion2$
```

5. Please reboot your Linux device to run the driver, or the driver will not be useful.

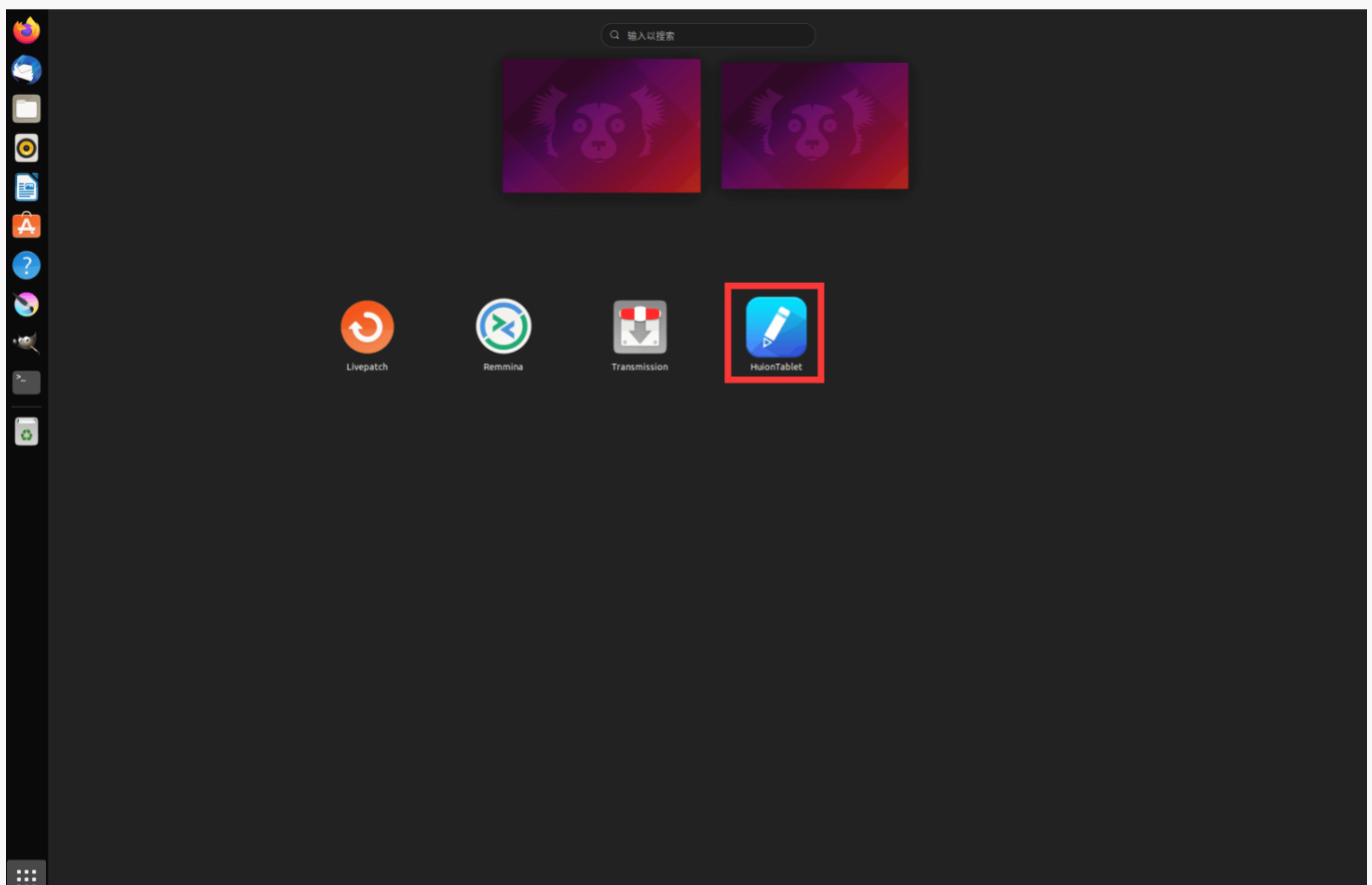

Steps to Uninstall:

1. Open the command window in the folder of the driver.

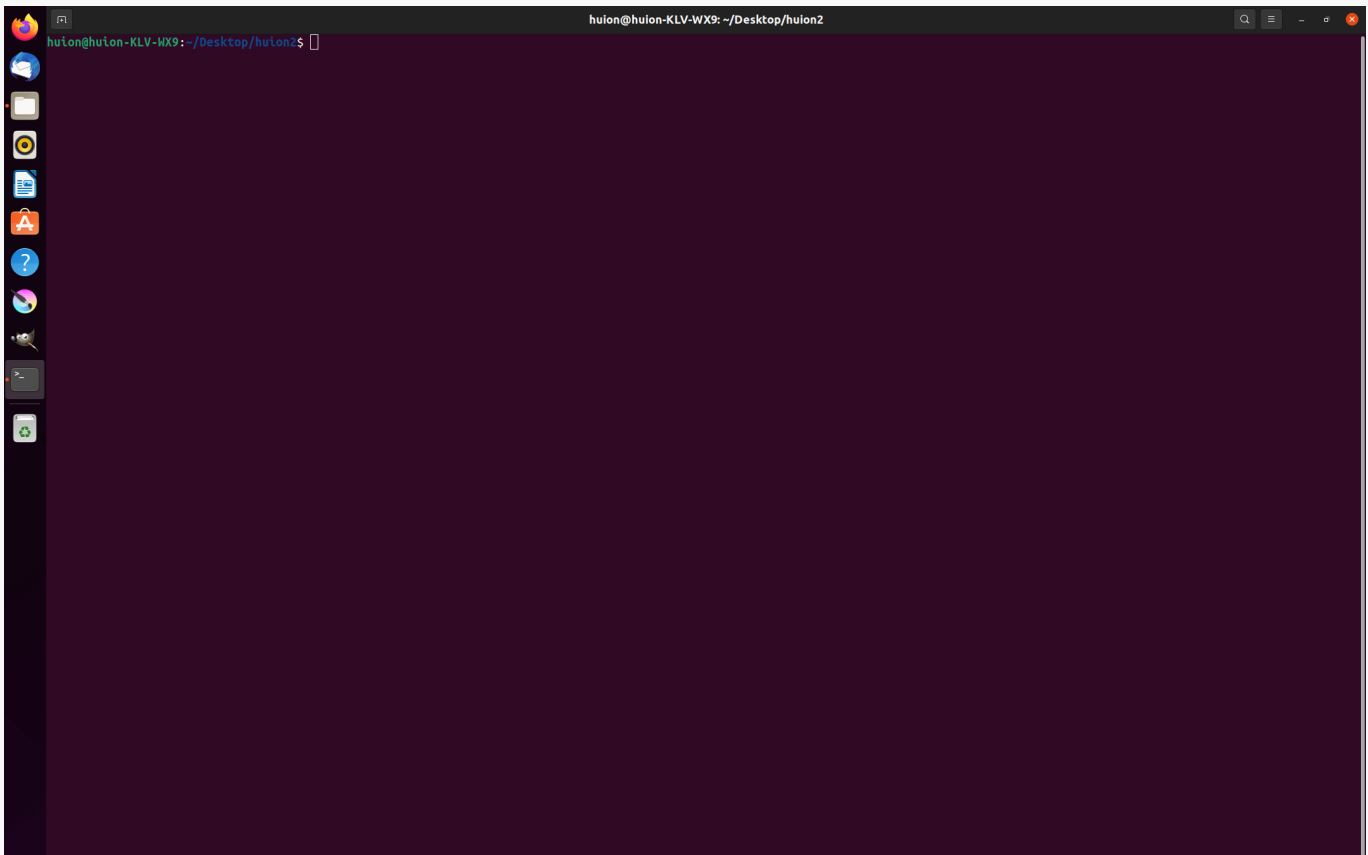

Input the following command in the command window: "sudo sh uninstall.sh", and press the enter key on the keyboard to make your Linux device execute it.

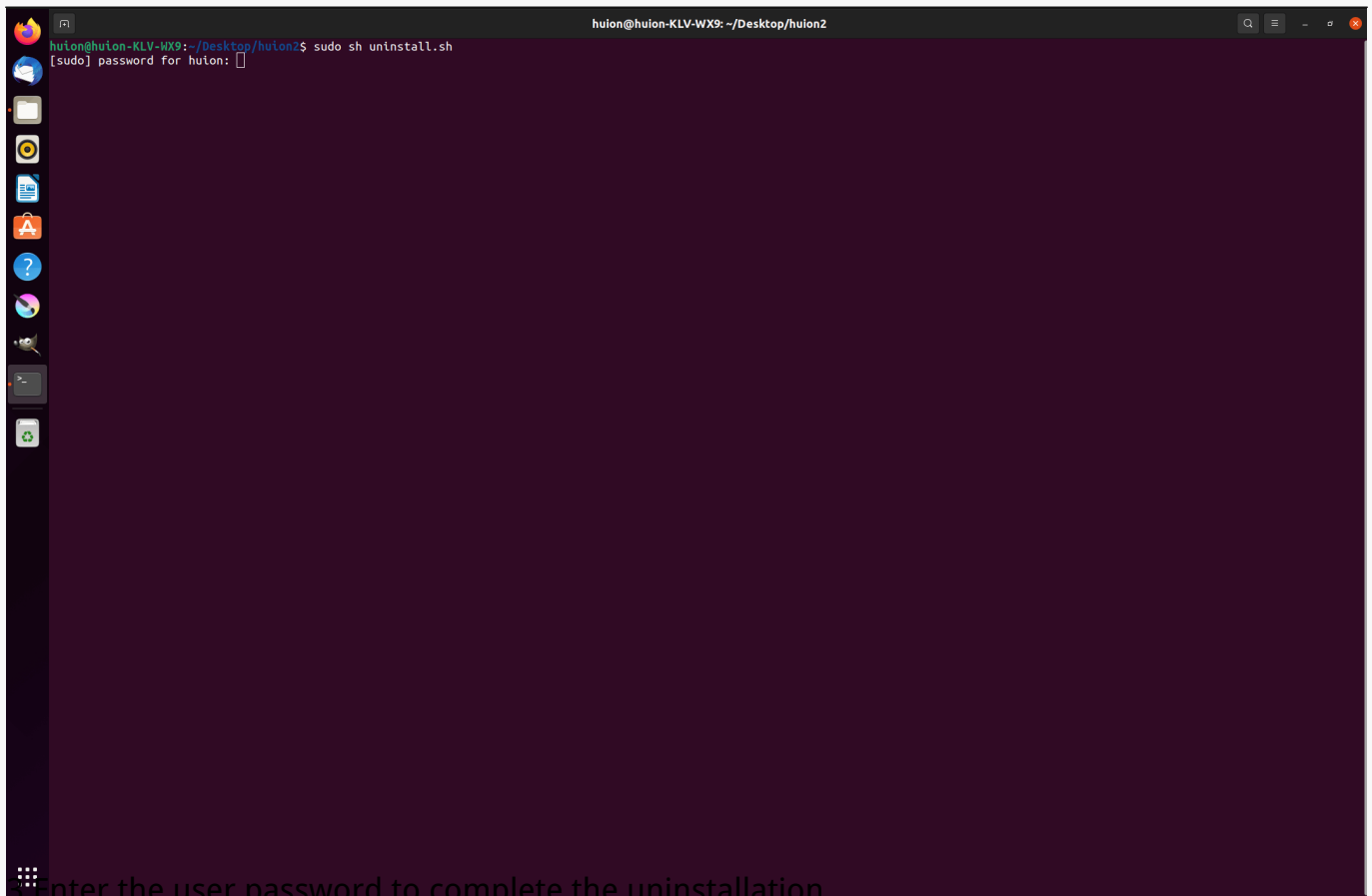

A terminal window titled "huion@huion-KLV-WX9: ~/Desktop/huion2" is shown. The prompt is "huion@huion-KLV-WX9:~/Desktop/huion2\$". The user has entered "sudo sh uninstall.sh". The prompt has changed to "[sudo] password for huion:" and there is an empty input field. The terminal background is dark purple. On the left side, there is a vertical dock with various application icons.

```
huion@huion-KLV-WX9:~/Desktop/huion2$ sudo sh uninstall.sh
[sudo] password for huion: 
```

5. Enter the user password to complete the uninstallation.

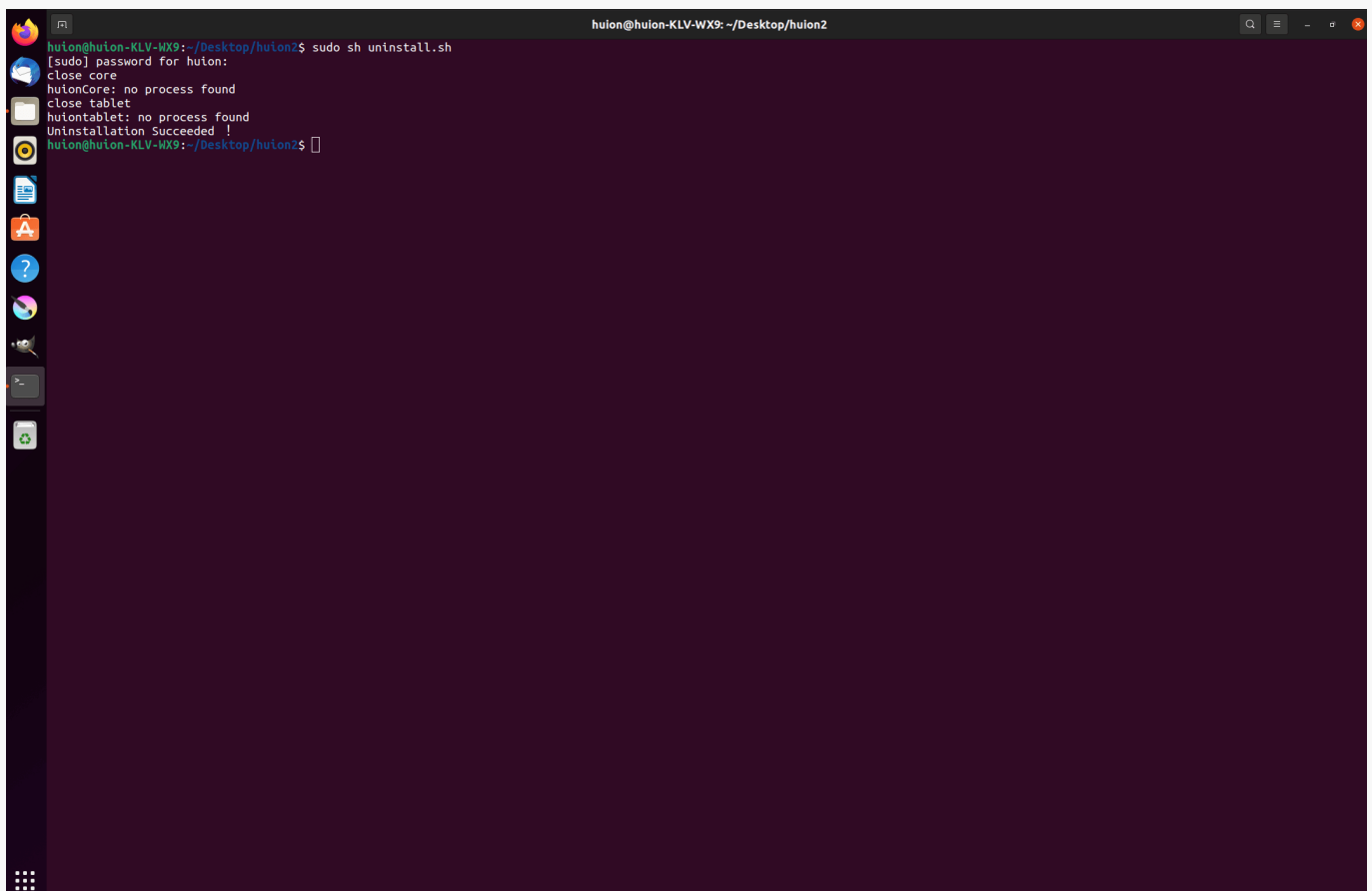

The same terminal window is shown, but now the password has been entered. The terminal output shows the following messages: "close core", "huionCore: no process found", "close tablet", "huiontablet: no process found", and "Uninstallation Succeeded!". The prompt has returned to "huion@huion-KLV-WX9:~/Desktop/huion2\$".

```
huion@huion-KLV-WX9:~/Desktop/huion2$ sudo sh uninstall.sh
[sudo] password for huion:
close core
huionCore: no process found
close tablet
huiontablet: no process found
Uninstallation Succeeded !
huion@huion-KLV-WX9:~/Desktop/huion2$
```

2. Instructions for installing the driver package file in deb format.

Linux operating systems supported:

Ubuntu

Steps to Install:

1. Open the folder and double-click the driver file in deb format to enter the system default interface of installing the driver on the application store, then click to install.



2. Enter the user password to complete the installation.

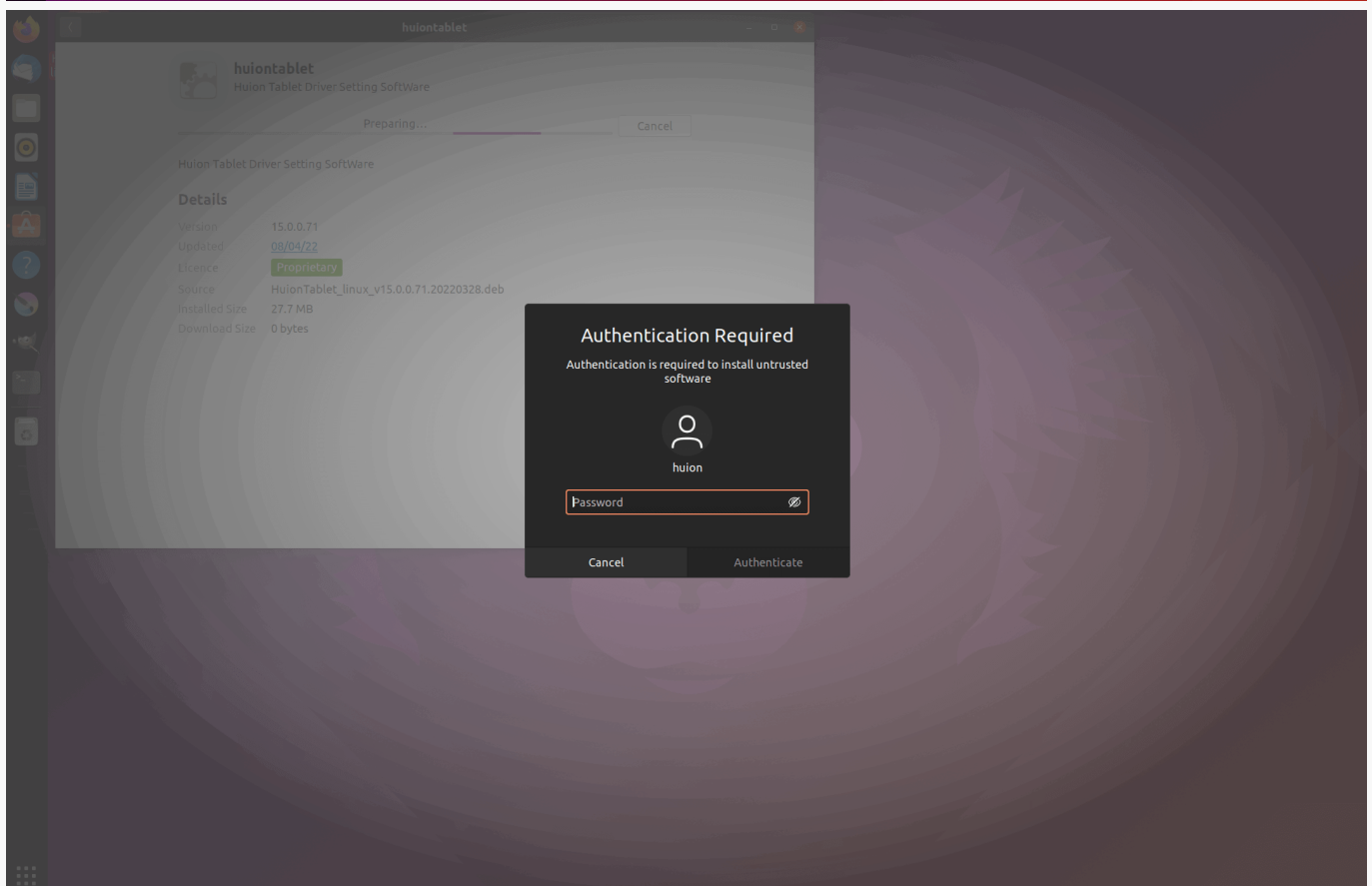
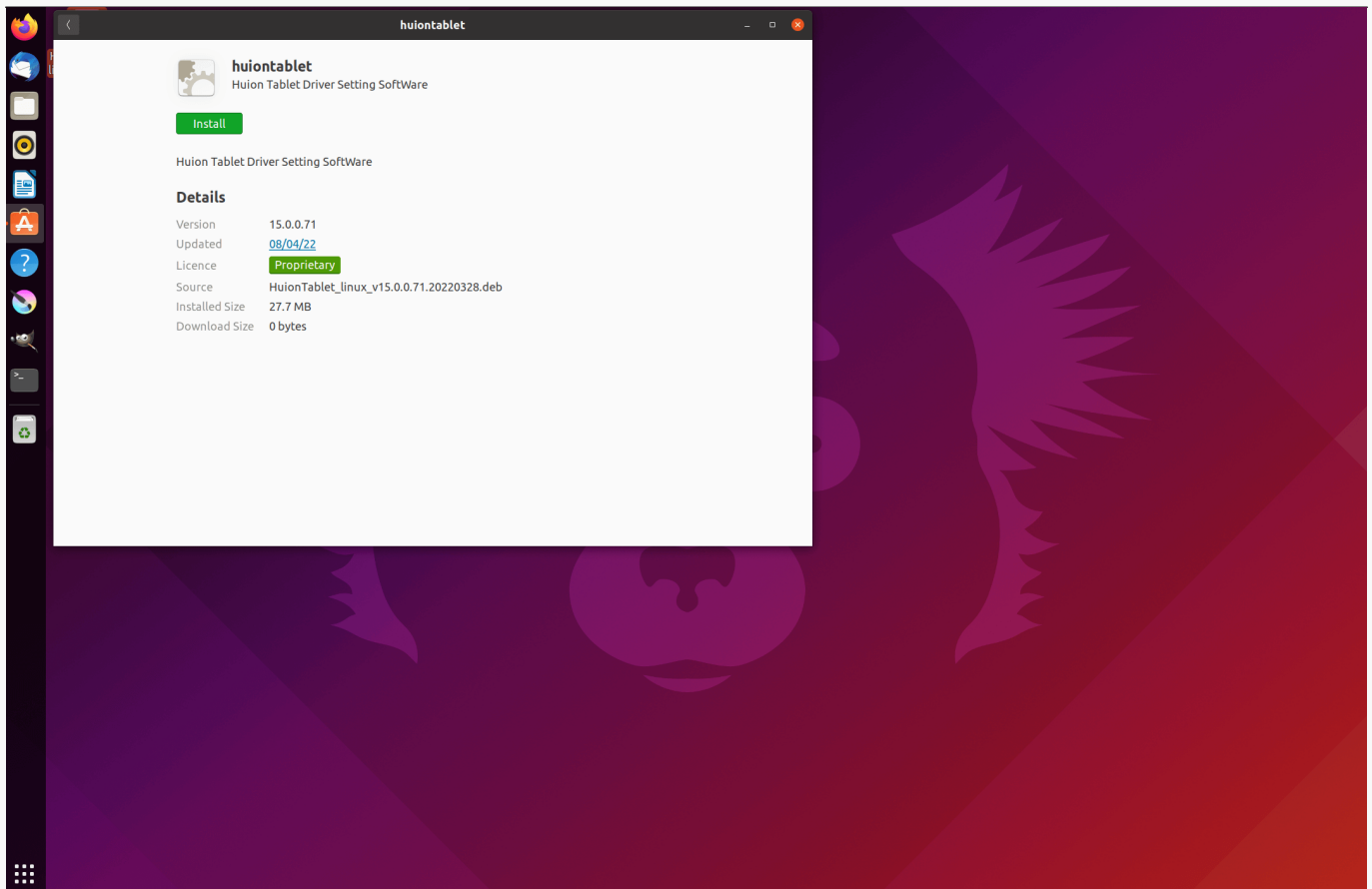

3. Please reboot your Linux device to run the driver, or the driver will not be useful.

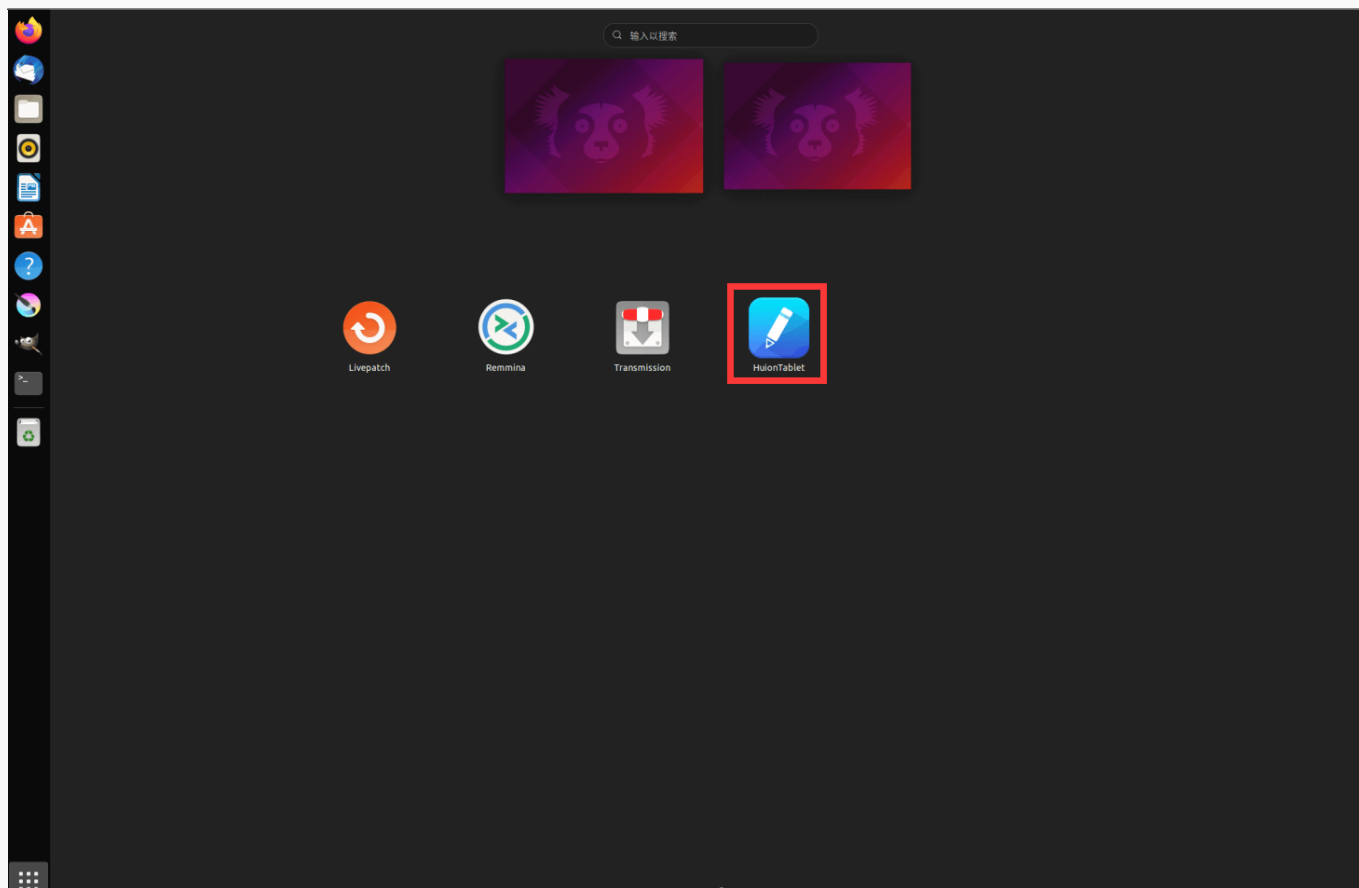

Tips: Please ensure that your Linux device has been connected to the internet when installing the driver, or the installation will fail when entering the application store interface.

Steps to Uninstall:

1. Enter the interface of the installed applications on the system's built-in application store.
2. Find the driver and click to uninstall it.

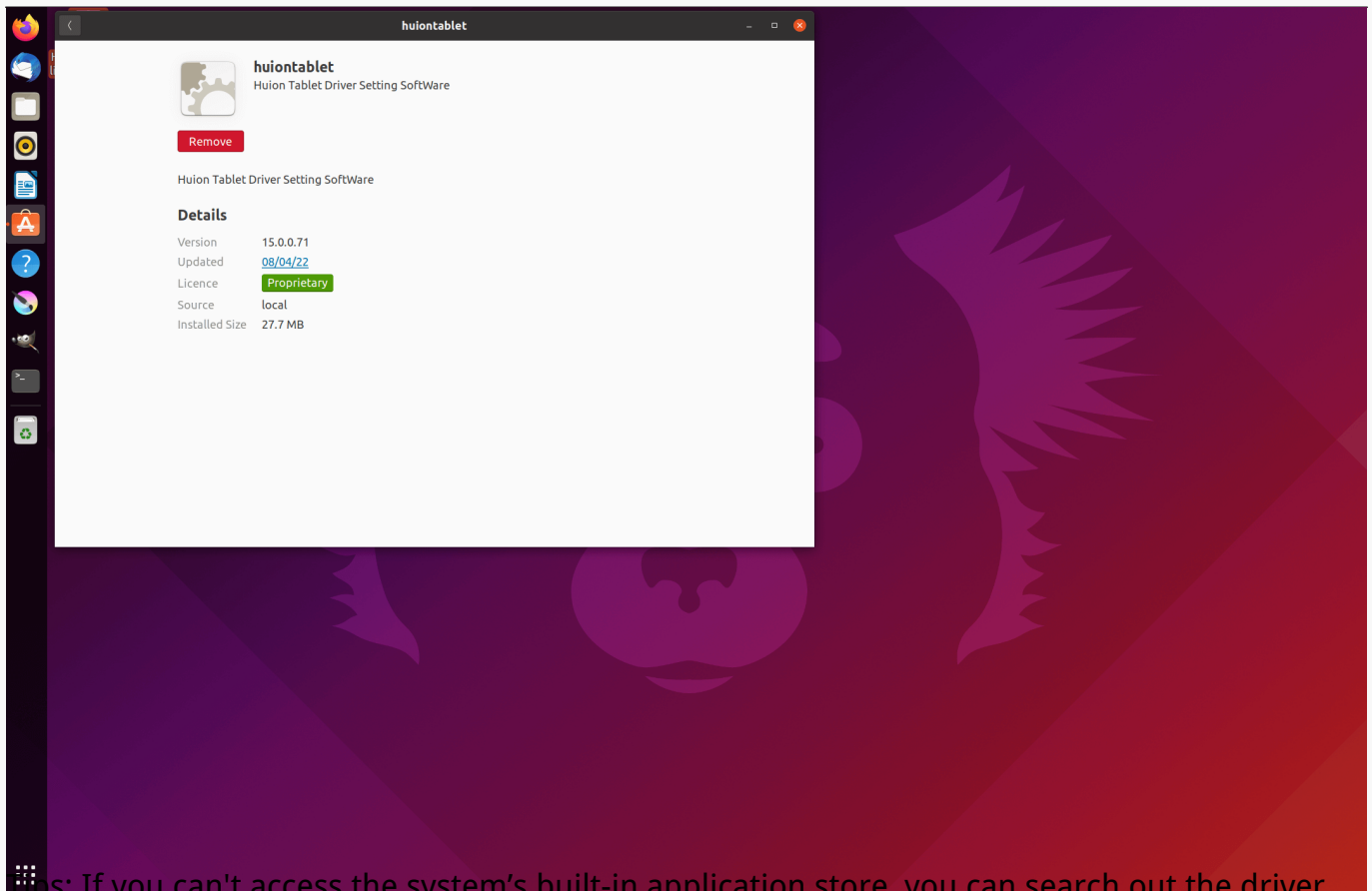

Tips: If you can't access the system's built-in application store, you can search out the driver file, huiontablet_xxx.deb, then double-click it to enter the installation interface, and click the remove button to uninstall it.

Driver Interface Preview

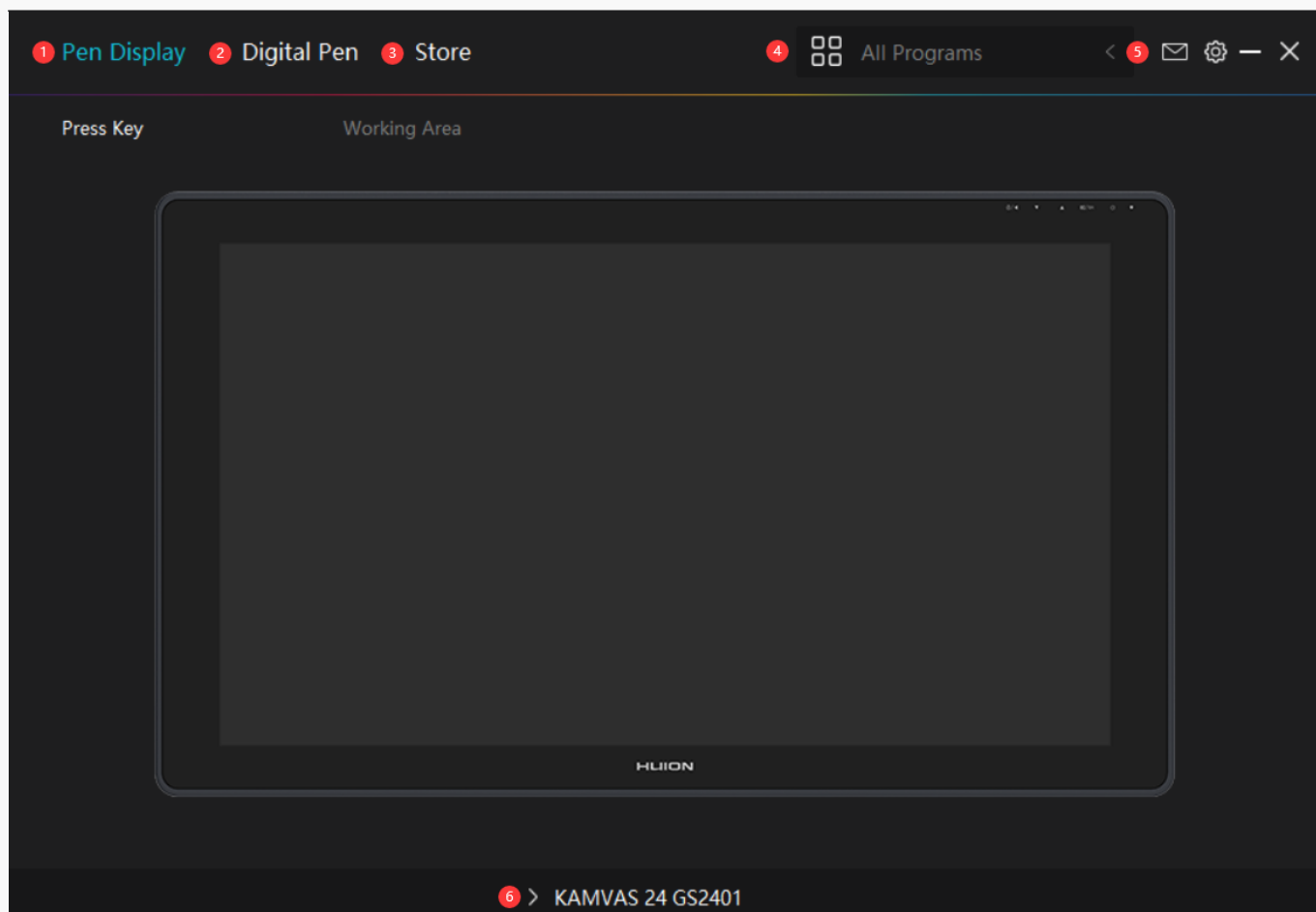

1. Pen Display

Pen Tablet function setting interface, the users can set the device function on this interface.

[See Section](#)

2. Digital Pen

The users can set the Pen function on this interface. About Press Key, Mode selection, Pressure Sensitivity Adjustment and Pressure Test.

[See Section](#)

3. Store

Huion Store, where you can get the latest information about the product such as its FAQ or sales promotion. Additionally, you can also purchase other products or accessories on Huion Store.

4. Add Programs

You can customize different functions on the current device for different programs.

When select All programs, the setting of the device is valid for every program.

By clicking Add a Program from the drop-down list, you can set the functions for a specific program and hence have unique settings for different programs. After that, when launching a specific program, the Driver will automatically recognize it and the setting features will change to its corresponding one.

5. Setting

The users can set the Driver function on this interface. About Device Information, Backup Setting, General Setting and Driver Update.

[See Section](#)

6. Switch between Devices

Driver can support the connection to two digital drawing devices at the same time. When these devices are sharing the same Driver with the current device, users can customize the settings of the devices by switching the Driver interface to the corresponding one.

Pen Display Setting

Working Area

Select the Working Area tab to define the relationship between pen movement on the device and cursor movement on the monitor screen.

By default the entire active area of device maps to the entire monitor. If more than one monitor is in use and you are in extended mode, you need to choose the related monitor on the driver interface which you are going to map to.

If your monitors are in mirror mode (All monitors display the same content), the device maps to the entire space on each monitor and the screen cursor is displayed on each monitor simultaneously.

1. Working Area Setting

Define the device area that will be mapped to the screen area.

[1] Full Area: the entire active area of the device. This is the default setting.

[2] Screen Ratio: As a general rule, be 16:9.

[3] Customized Area:

1> Enter coordinate values.

2> Drag the corners of the foreground graphic to select the screen area.

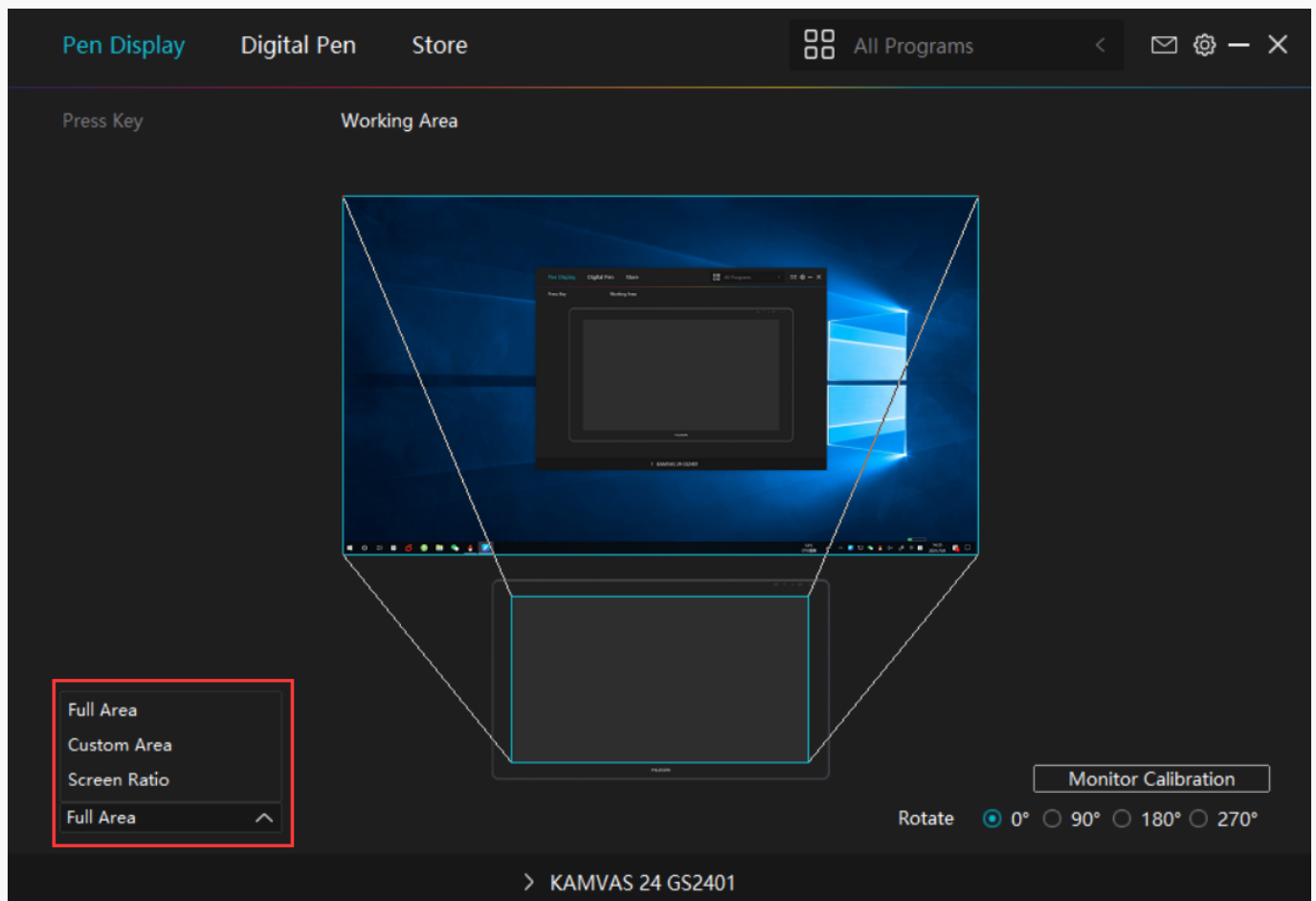

2. Rotate Working Area

By changing the direction of the device to adapt to the left and right hand operation. You can rotate the tablet by 0°, 90°, 180° or 270°.

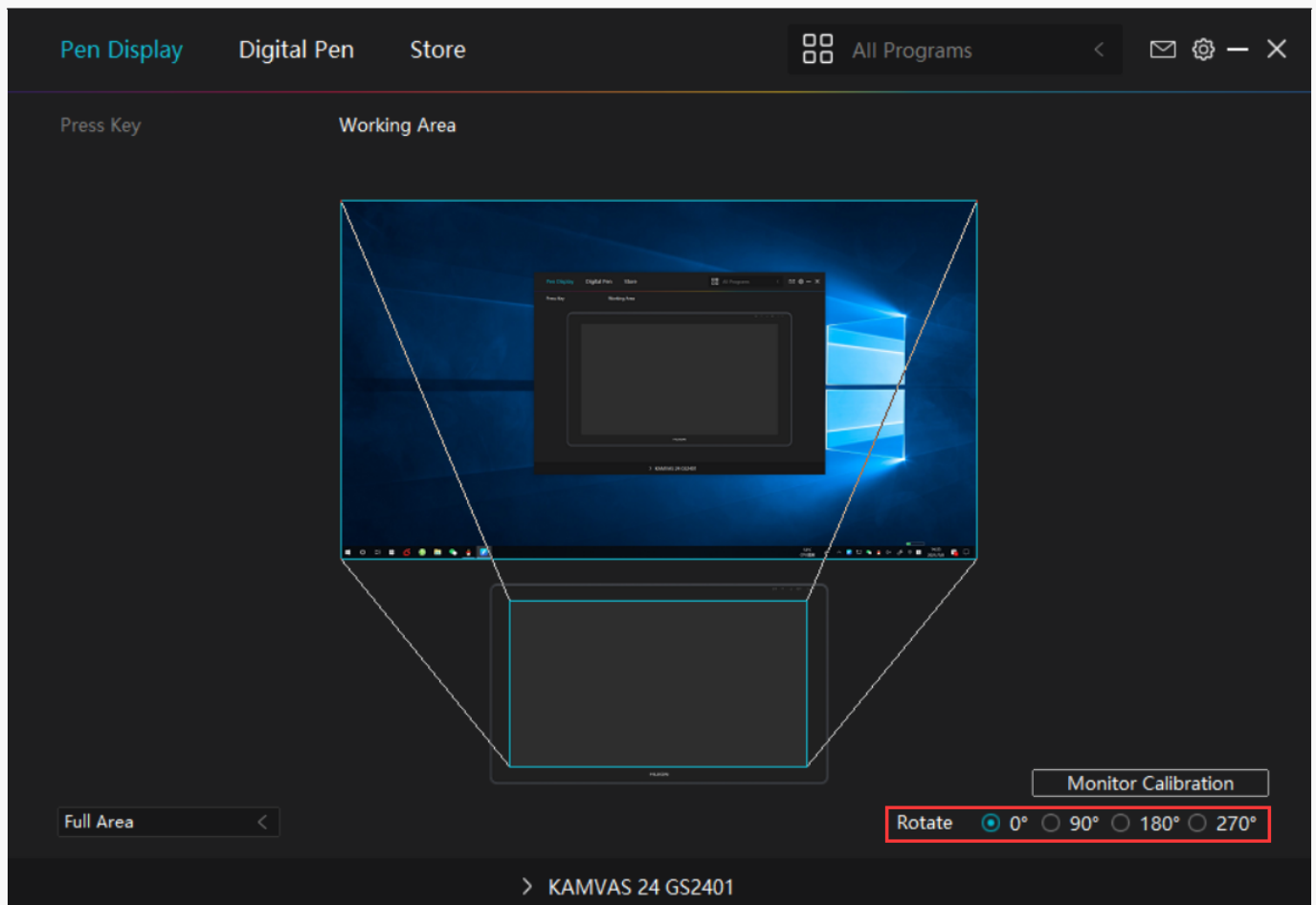

3. Monitor Calibration

Click "Cursor Calibration" to enter the calibration page and operate according to the prompts.

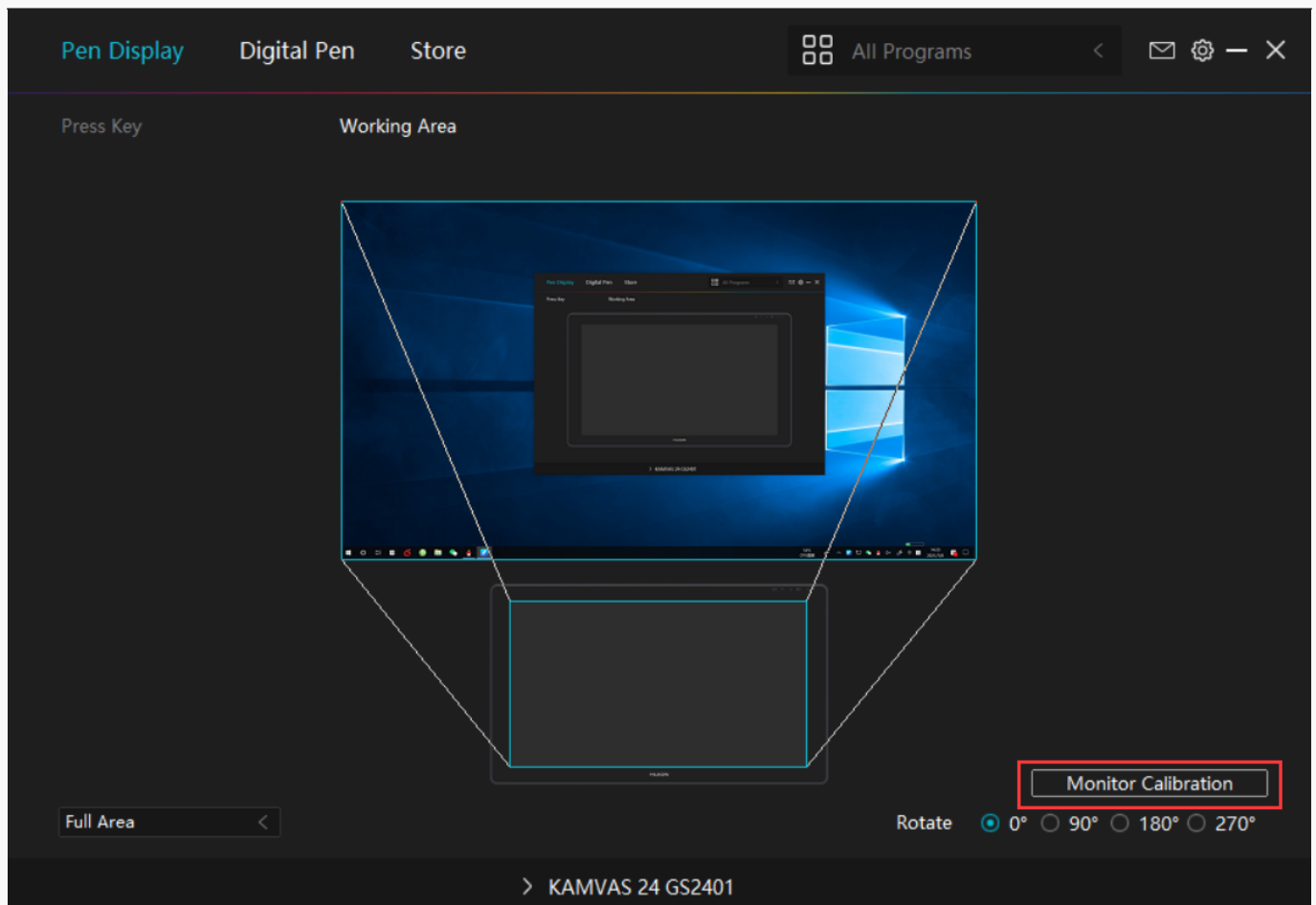

Please use the digital pen to click on the center red dot of the cross in a common pen-holding posture. You can cancel Calibration and restore default.

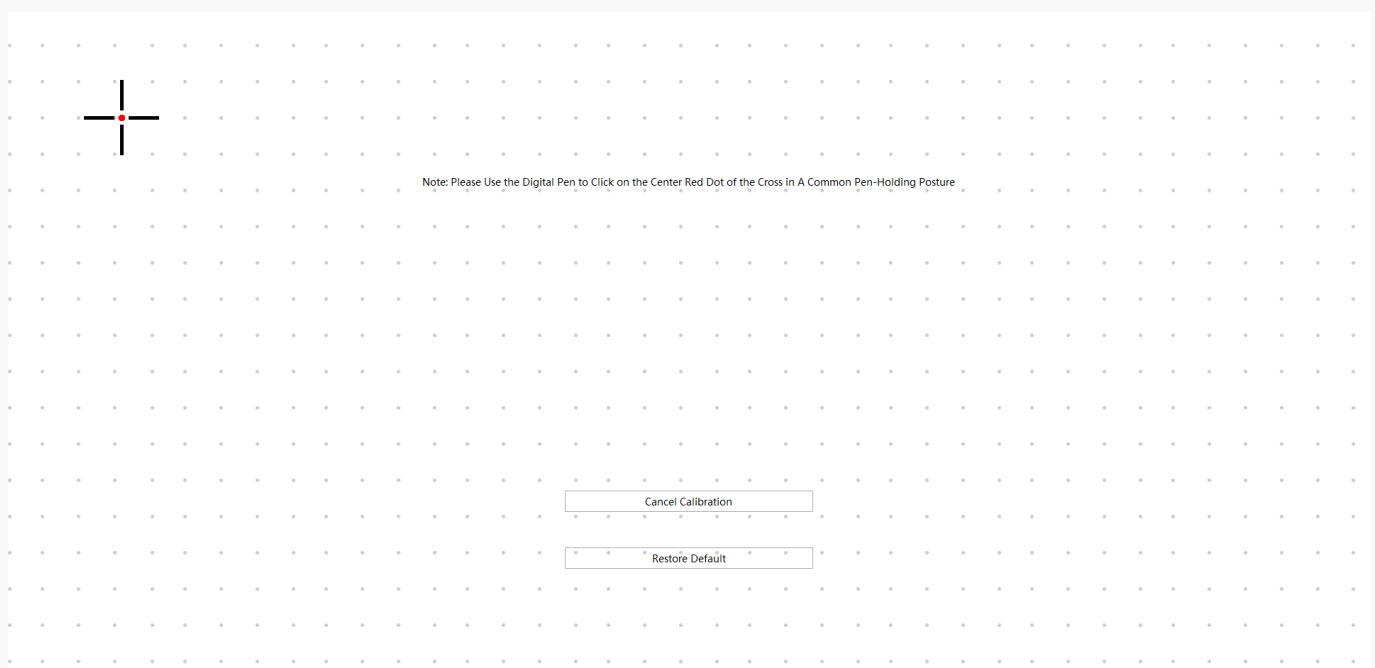

1. Press Key

The function setting is the same as the Press Key setting of the tablet. Please refer to it.

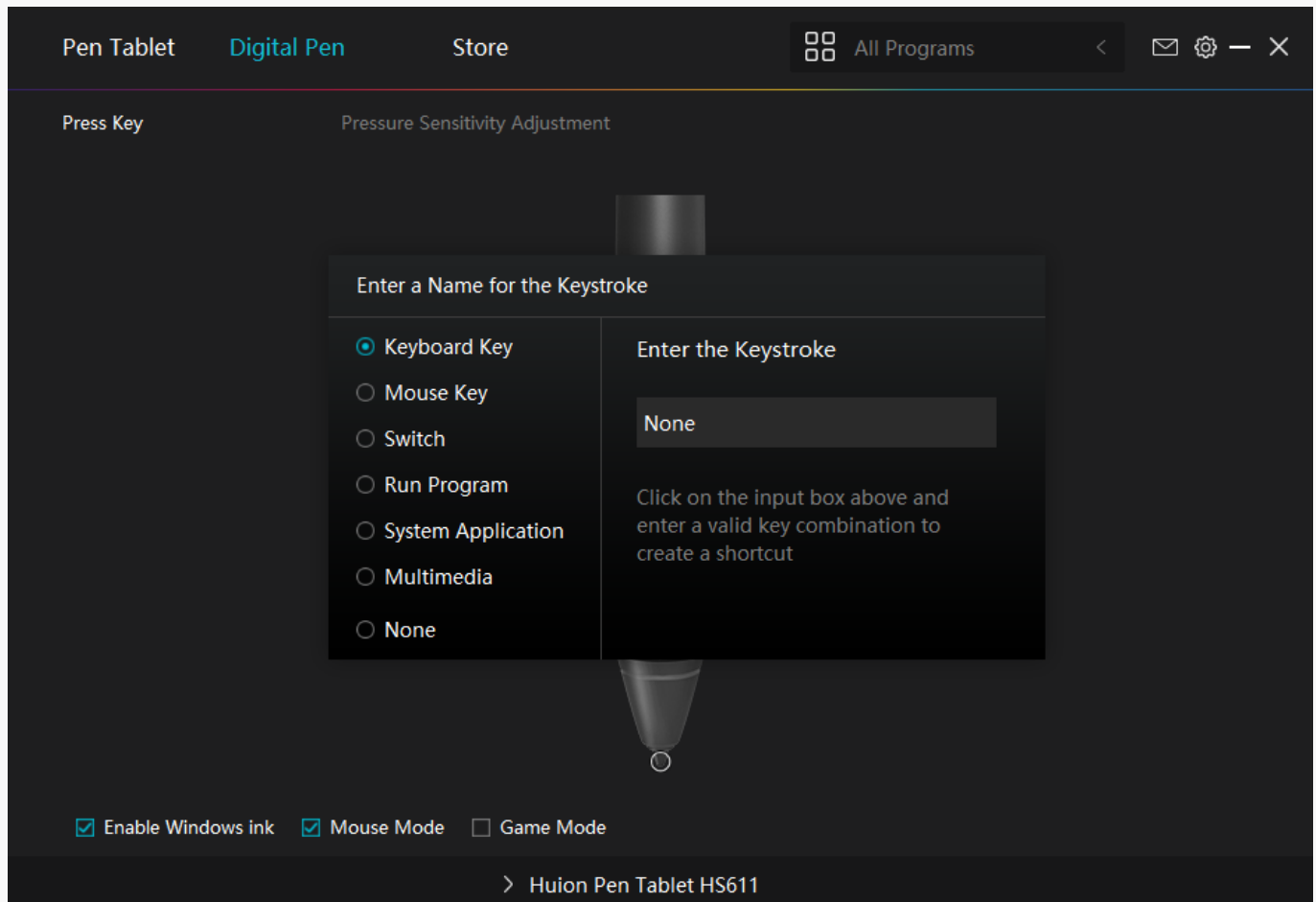

① Keyboard Key

Click on the input box above and enter a valid key combination to create a shortcut. For example "Ctrl+A", "Ctrl+Z", and so on.

Enetr a Name for the Keystroke

Keyboard Key

Mouse Key

Switch

Run Program

System Application

Multimedia

None

Enetr a Keystroke

None

Click on the input box above and enter a valid key combination to creat a shortcut.

② Mouse Key

Select the function of a Mouse or Wheel. Please see the picture below for detailed functions.

Mouse: Left Button, Right Button, Middle Button.

Wheel: Wheel Forward, Wheel Backward.

Double-Left Click.

Enetr a Name for the Keystroke

Keyboard Key

Mouse Key

Switch

Run Program

System Application

Multimedia

None

Mouse Left Button

Mouse Right Button

Mouse Middle Button

Double-Left Click

Wheel Forward

Wheel Backward

Ctrl

Shift

Alt

Win

③ Switch

Select Switch Screen or Switch Brush.

Note: Some software does not support the "Switch Brush" function.

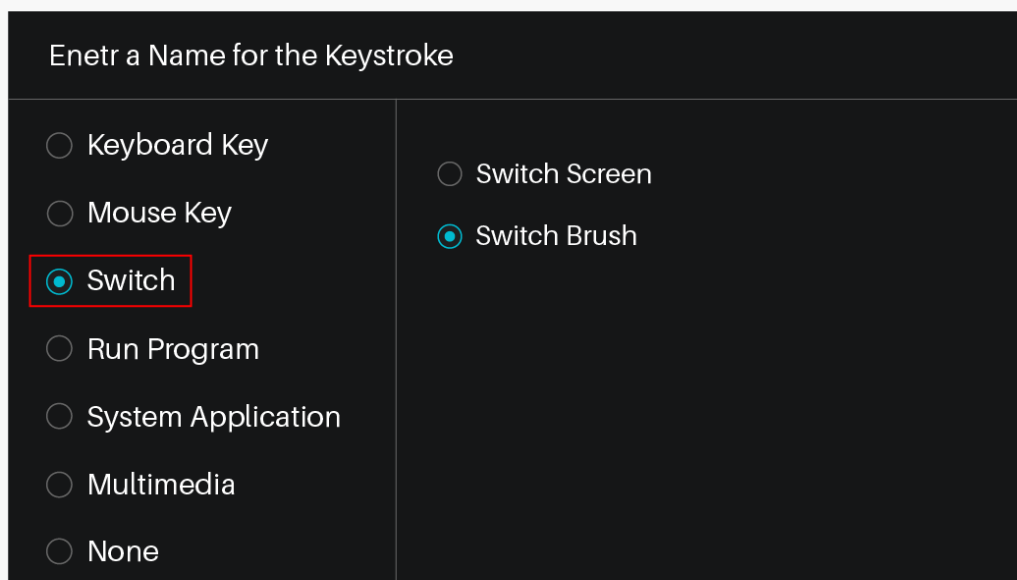

④ Run Program

Browse and select a program that you want to launch quickly. After the setting, you can launch that program with just a single press.

Enetr a Name for the Keystroke

<input type="radio"/> Keyboard Key <input type="radio"/> Mouse Key <input type="radio"/> Switch <input checked="" type="radio"/> Run Program <input type="radio"/> System Application <input type="radio"/> Multimedia <input type="radio"/> None	<p>Select a Program</p> <p>Program Path</p> <p>Click on the "Browse" to select a file.</p> <p>Browse</p>
---	--

⑤ System Application

The table below are the functions of Windows and Mac Systems that can be customized on the Keys.

Enetr a Name for the Keystroke

<input type="radio"/> Keyboard Key <input type="radio"/> Mouse Key <input type="radio"/> Switch <input type="radio"/> Run Program <input checked="" type="radio"/> System Application <input type="radio"/> Multimedia <input type="radio"/> None	<input type="radio"/> Lock the Screen <input checked="" type="radio"/> Sleep <input type="radio"/> Power Off <input type="radio"/> Show/Hide Desktop Icon <input type="radio"/> Task View <input type="radio"/> Start Menu
---	---

⑥ Multimedia

To realize the functions such as previous song, next song, play/pause, volume up, volume down.

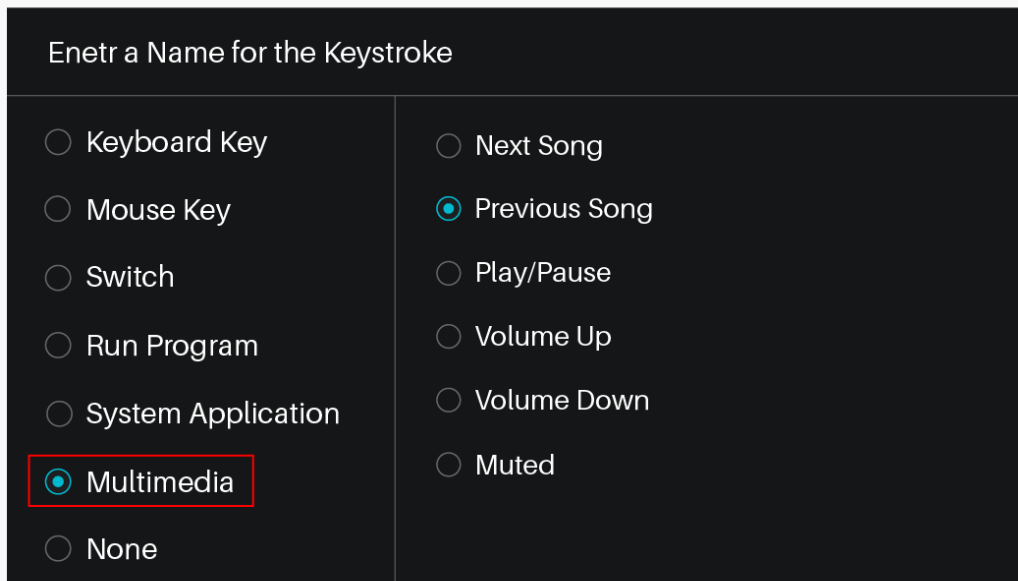

The image shows a dark-themed settings window titled "Enter a Name for the Keystroke". It contains two columns of radio button options. The "Multimedia" option in the left column is selected and highlighted with a red rectangular box. The "Previous Song" option in the right column is also selected, indicated by a blue dot in its radio button.

Enter a Name for the Keystroke	
<input type="radio"/> Keyboard Key	<input type="radio"/> Next Song
<input type="radio"/> Mouse Key	<input checked="" type="radio"/> Previous Song
<input type="radio"/> Switch	<input type="radio"/> Play/Pause
<input type="radio"/> Run Program	<input type="radio"/> Volume Up
<input type="radio"/> System Application	<input type="radio"/> Volume Down
<input checked="" type="radio"/> Multimedia	<input type="radio"/> Muted
<input type="radio"/> None	

⑦ None

When select None, the keys will have no function.

2. Pen Nib Activity

The pen nibs can be set to be Valid/Invalid as needed. Click the drop-down option to select. In Valid mode, the digital pen can be used normally. In Invalid mode, the digital pen has cursor movement, but cannot complete the specified action.

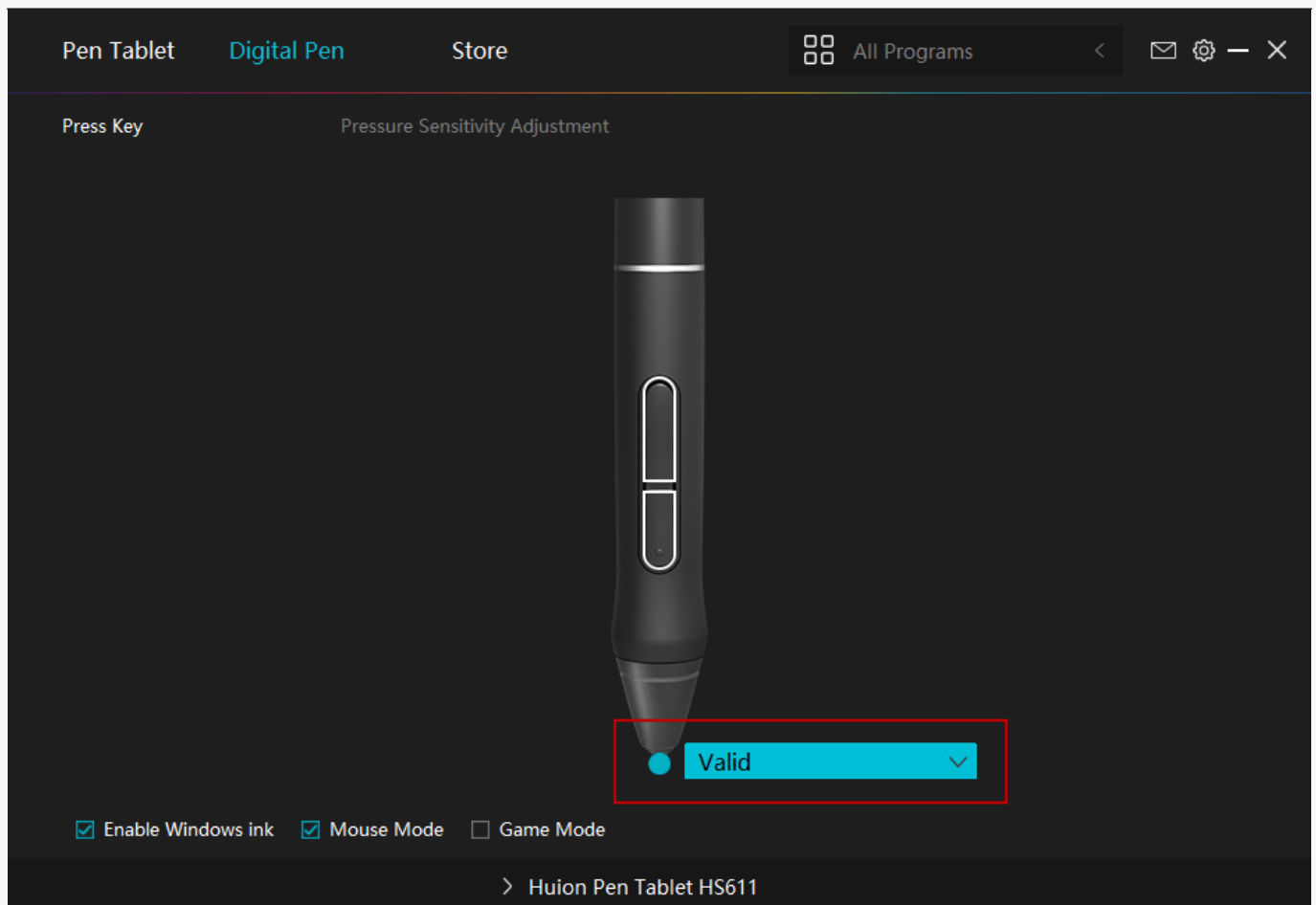

3. Enable Windows ink

Microsoft Windows provides extensive support for pen input. Pen features are supported in such as Microsoft Office, Windows Whiteboard, Adobe Photoshop CC, SketchBook 6 and so on.

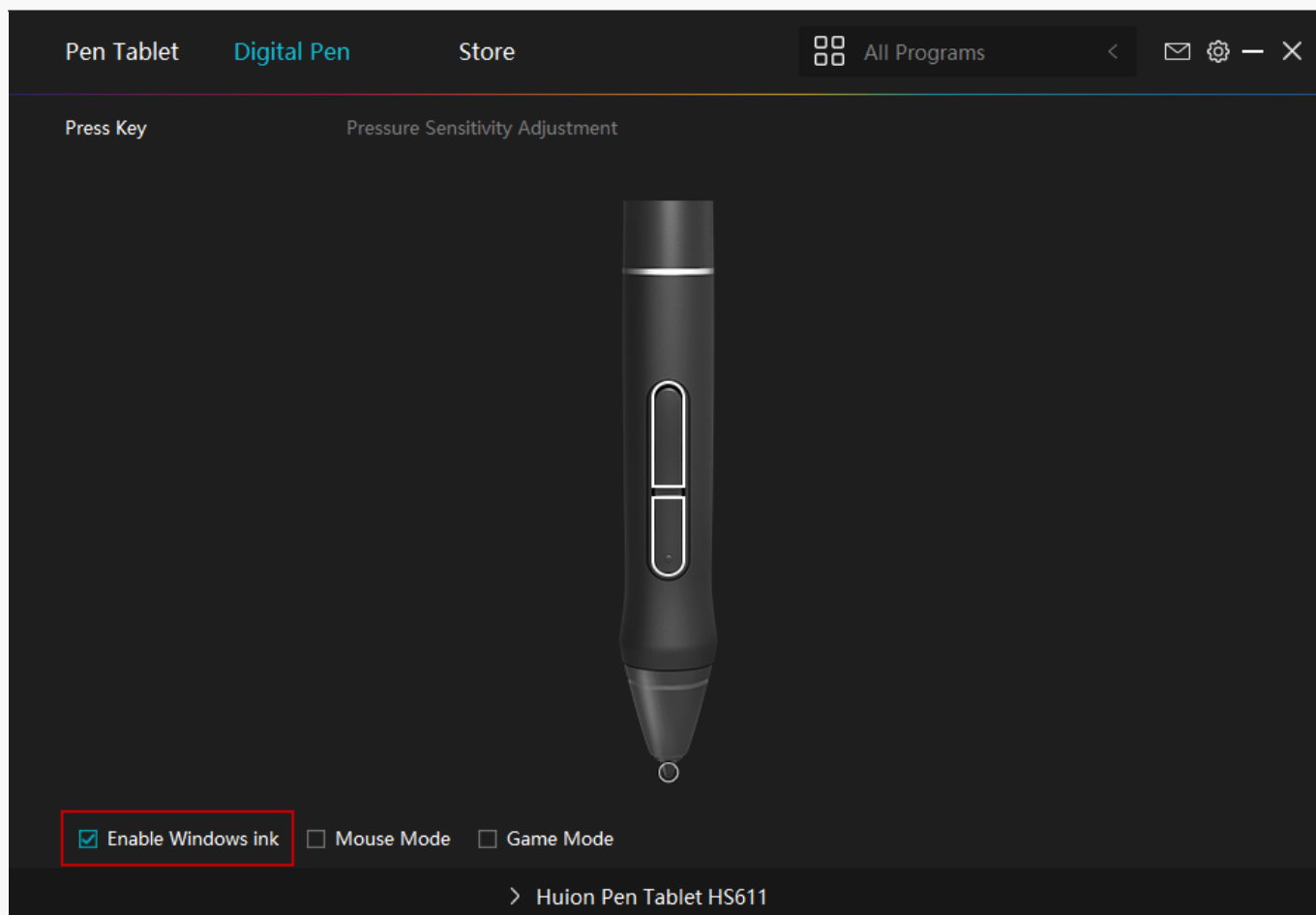

4. Pressure Sensitivity Adjustment

The pressure sensitivity will be changed by dragging the slider up and down, the smaller the value, the more pressure sensitive.

Click the Redo button at the top right of the Settings box to reset the pressure sensitivity to the default state.

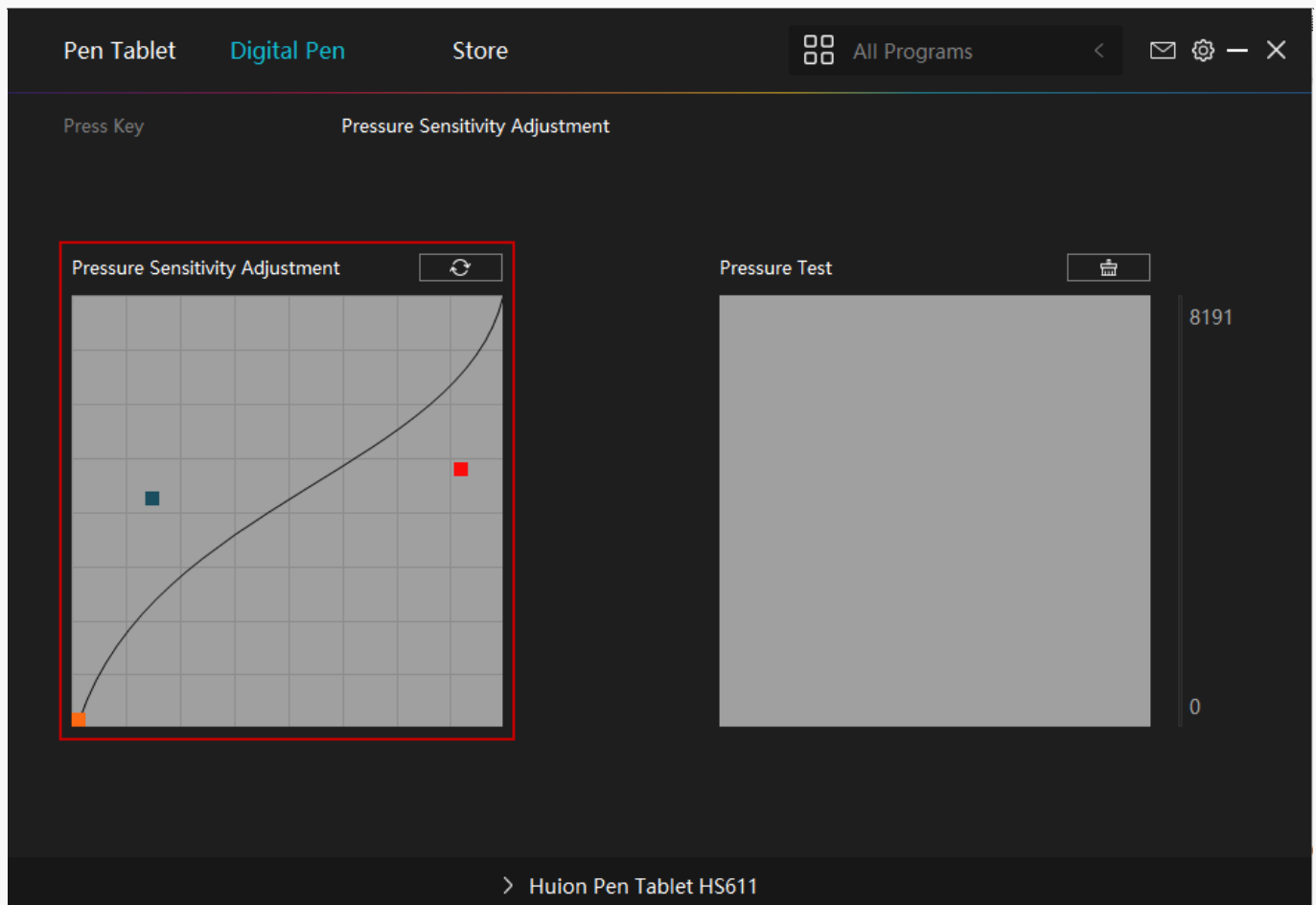

5. Pressure Test

You can gradually apply pressure to the stylus on the screen to test the pressure level. Click the Clear button to clear all the ink.

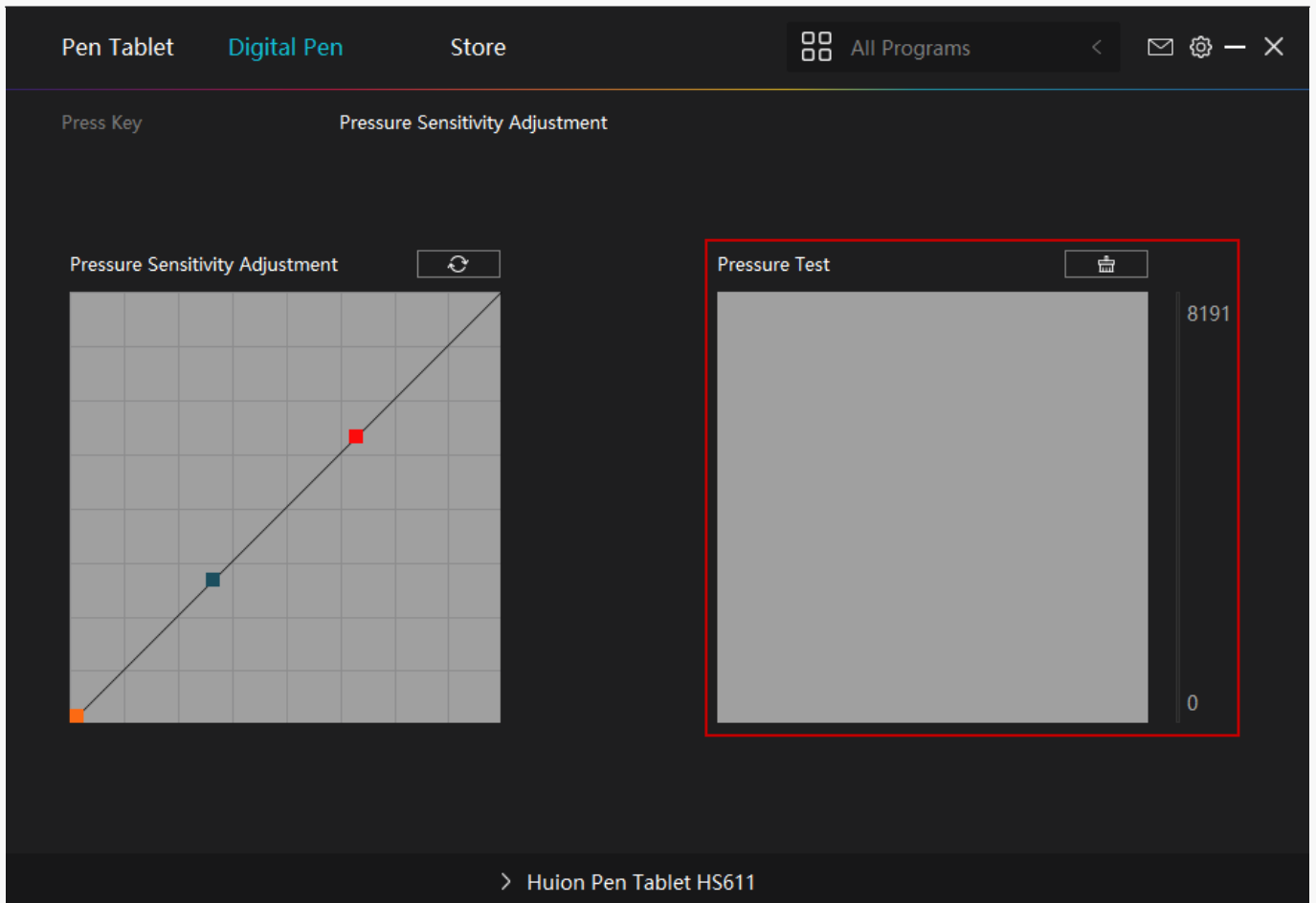

Driver Setting

1. Device

You can view product information.

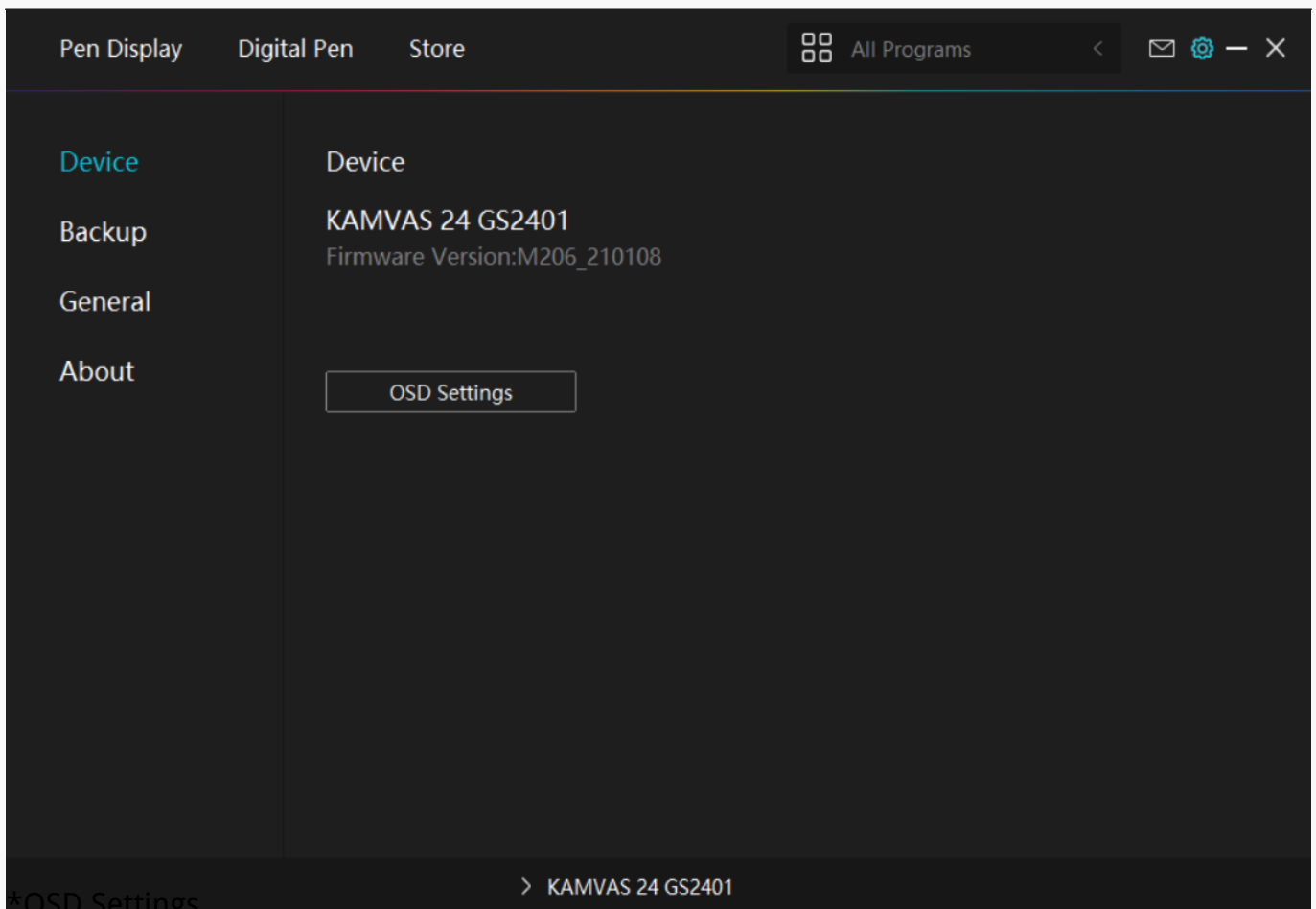

*OSD Settings

Scene Mode: You can choose the "Standard Mode", "Motion Mode", "Movie Mode" and "Gaming Mode".

Brightness: You can adjust the brightness of the screen.

Contrast Ratio: You can adjust the contrast of the screen.

Color Temperature: You can choose "6500K", "9500K", and "USER" mode. In the "USER" mode, you can customize the color temperature by adjusting the RGB value.

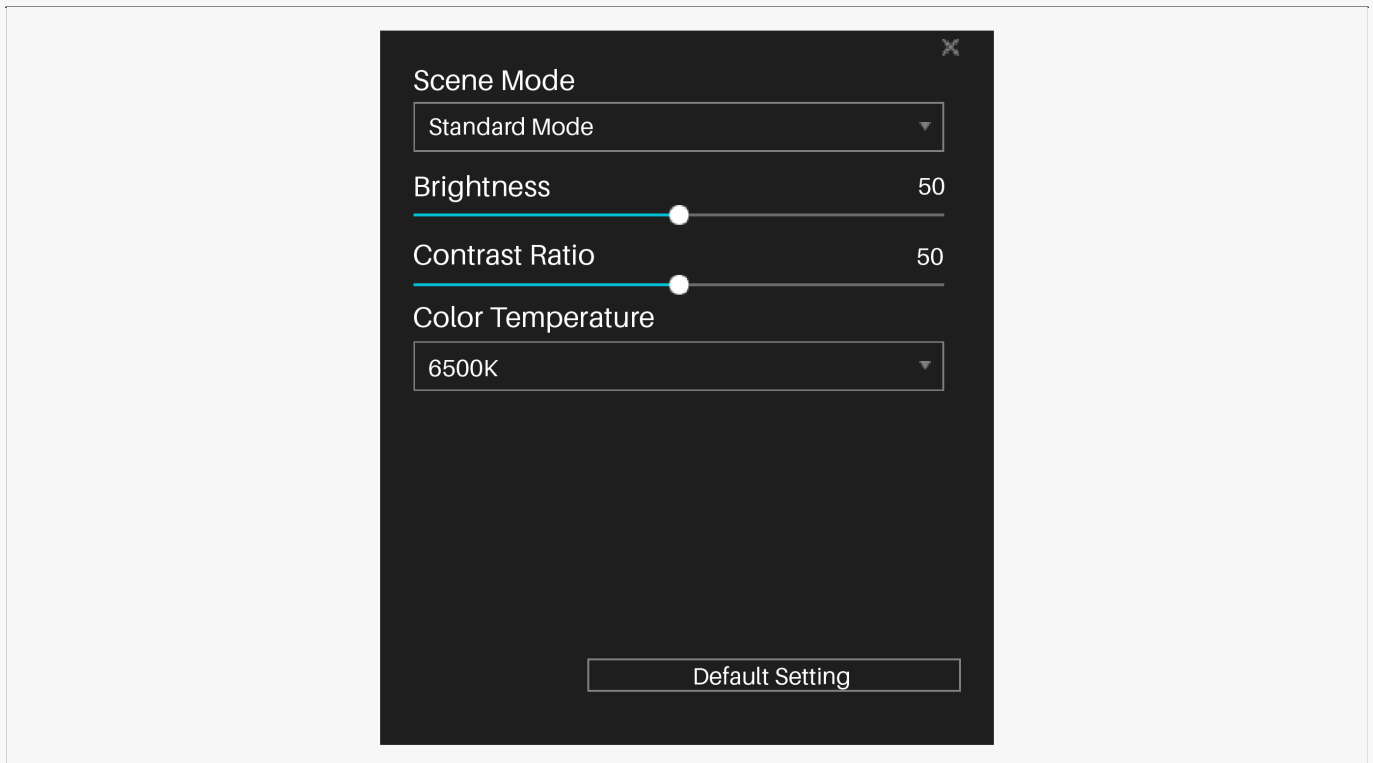

2. Backup

The Driver can import and export your custom settings, which helps to avoid repeated settings when launching a different program.

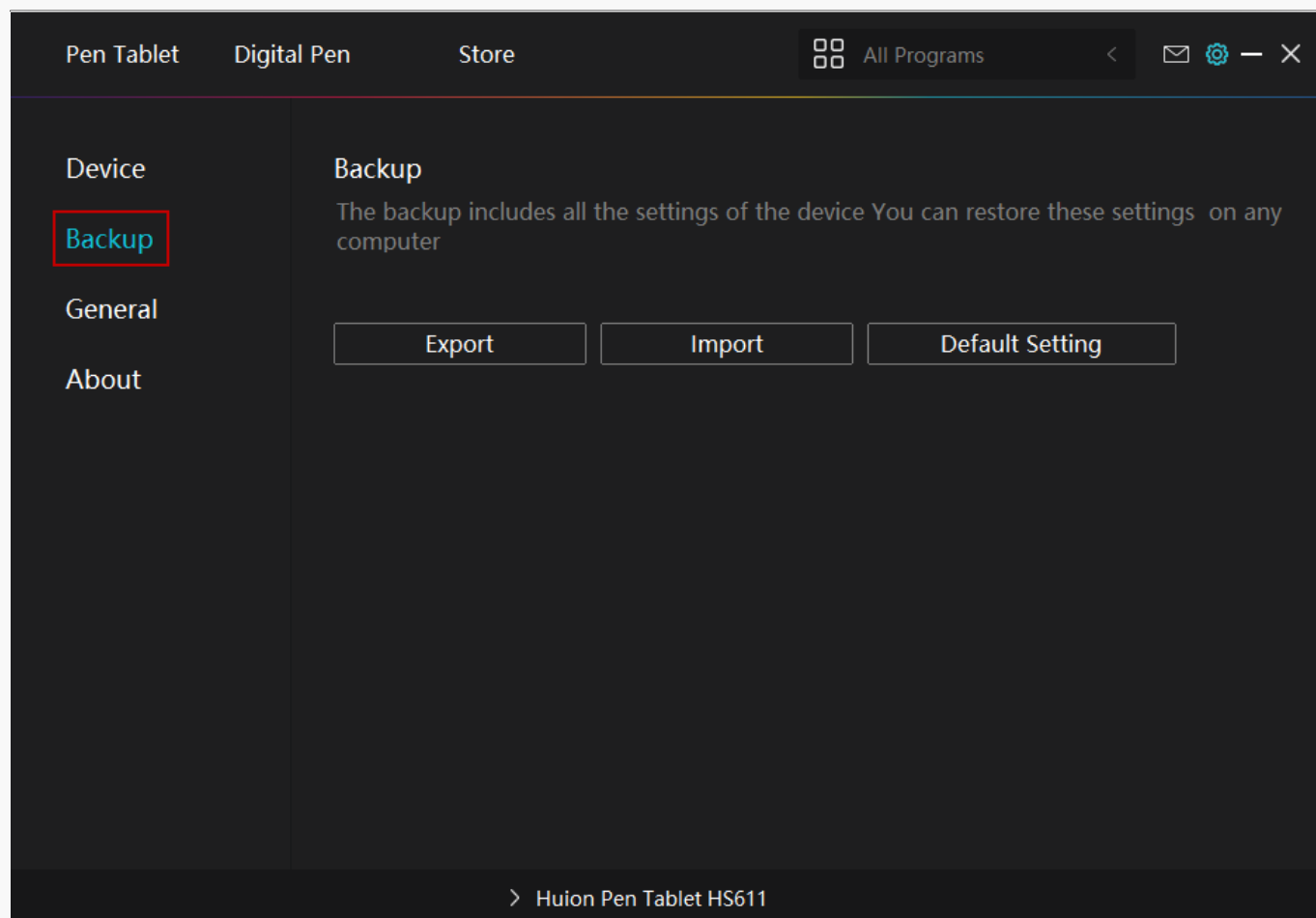

3. General Setting

[1] Language: Click the drop down menu to select a language.

[2] Color: You can select the color of the Driver interface among Dark, Blue, and Light according to your preference.

[3] Start Menu: Click to enable or disable AutoStart, New Message Alert, Automatic Updates.

[4] Hotkey: A hotkey can be used to call out the Driver interface quickly, you can set one according to your usage habits.

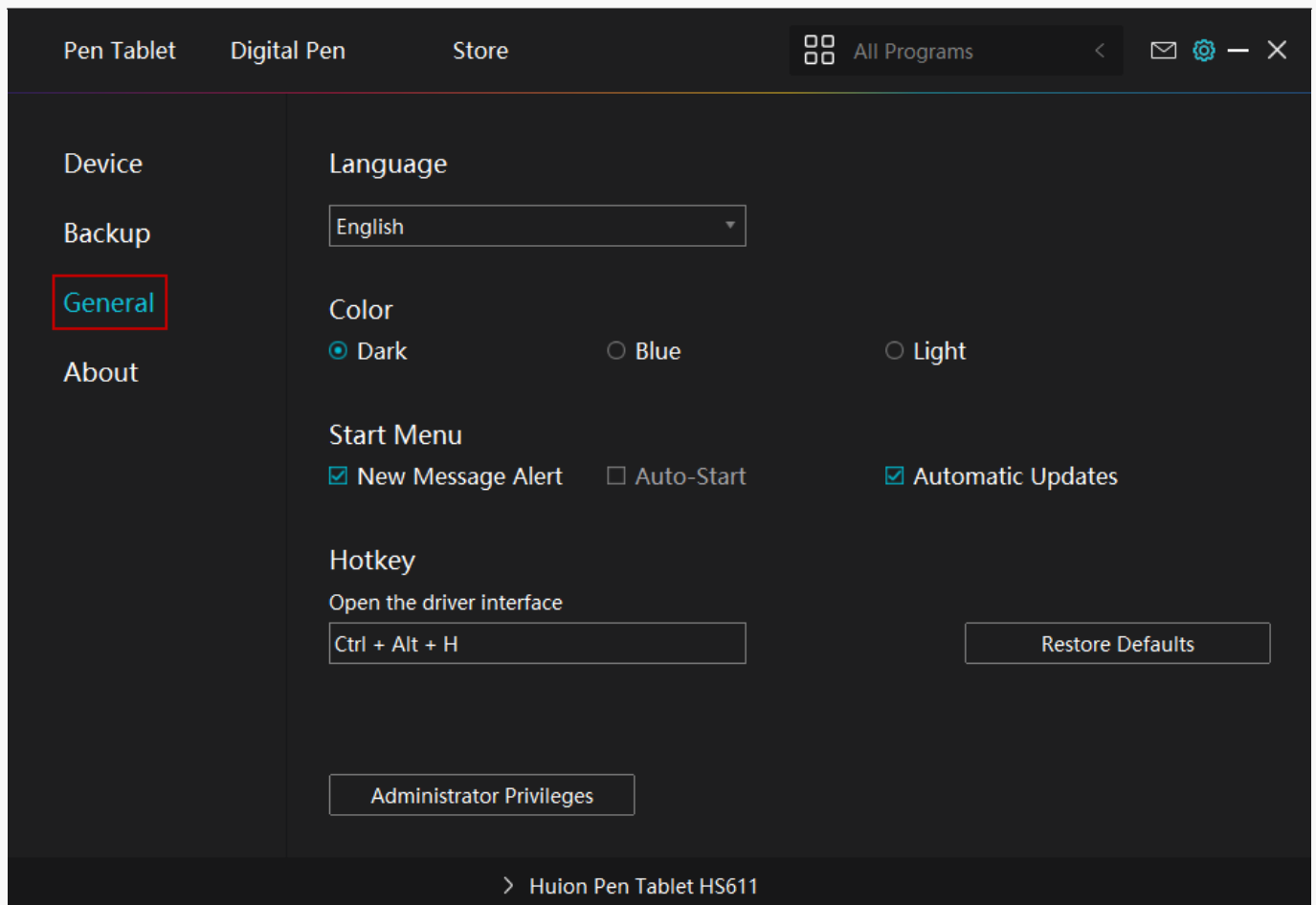

4. About

Users can check the Driver version number here. Click Check for Updates to view the latest Driver version and then follow the prompts to update the Driver if needed.

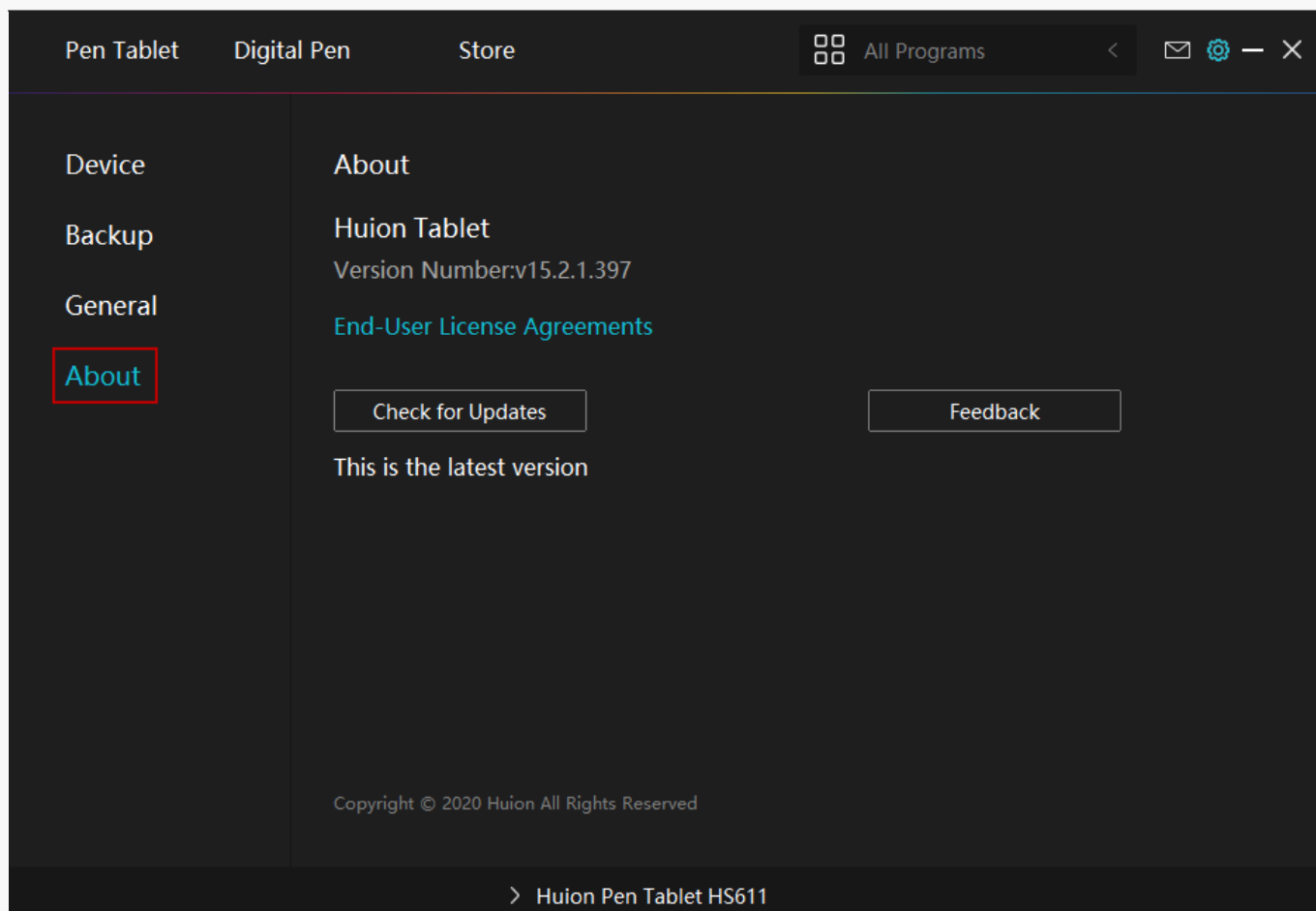

Digital Pen Basic Operation

Hold the Pen

Hold the pen as you hold a normal pen or pencil. Adjust your grip so that you can toggle the side switch easily with your thumb or forefinger. Be careful not to accidentally press the switch while drawing or positioning with the pen.

Note:

When not in use, place the pen in the pen case or on the desk. Do not place the pen on the surface of screen, which may interfere with the use of other screen cursor positioning equipment, may also cause your computer can not enter the sleep mode.

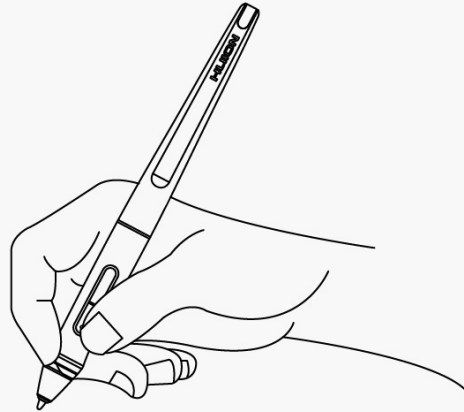

Position the cursor

Move the pen slightly above the active area without touching the screen surface, the cursor will move to the new position accordingly.

Press the pen tip on the screen to make a selection. Tap the screen once with the pen tip, or touch it to the screen with enough pressure to register a click.

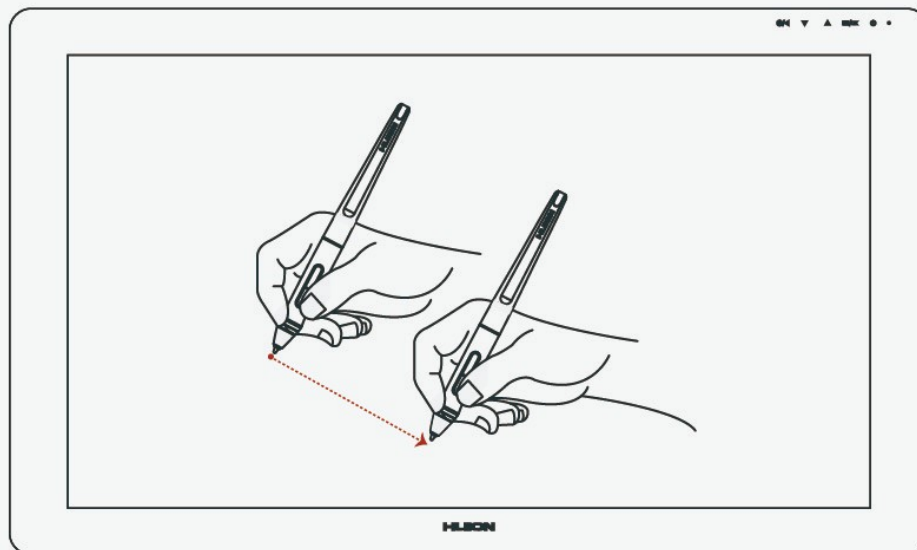

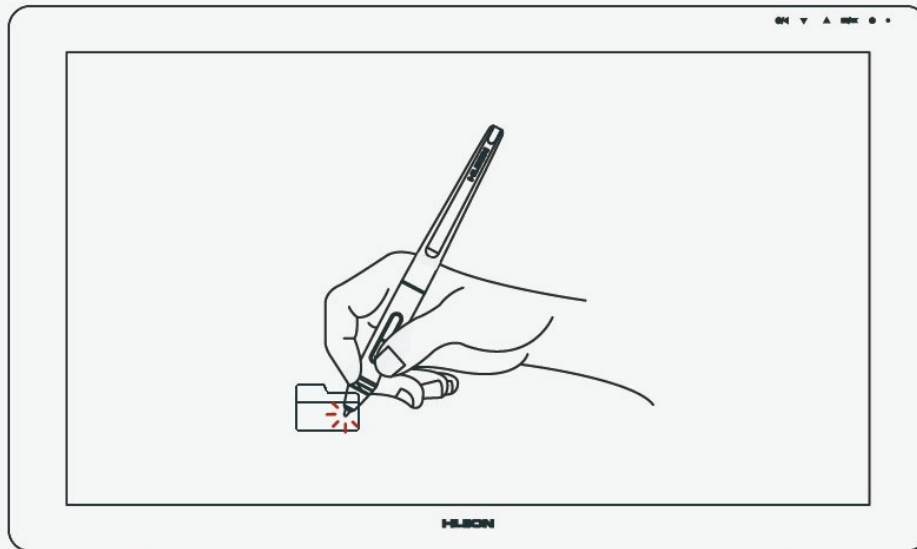

Click

Use the pen tip to tap once on the screen to register a click. Tap to highlight or select an item on the screen and double-click to open it.

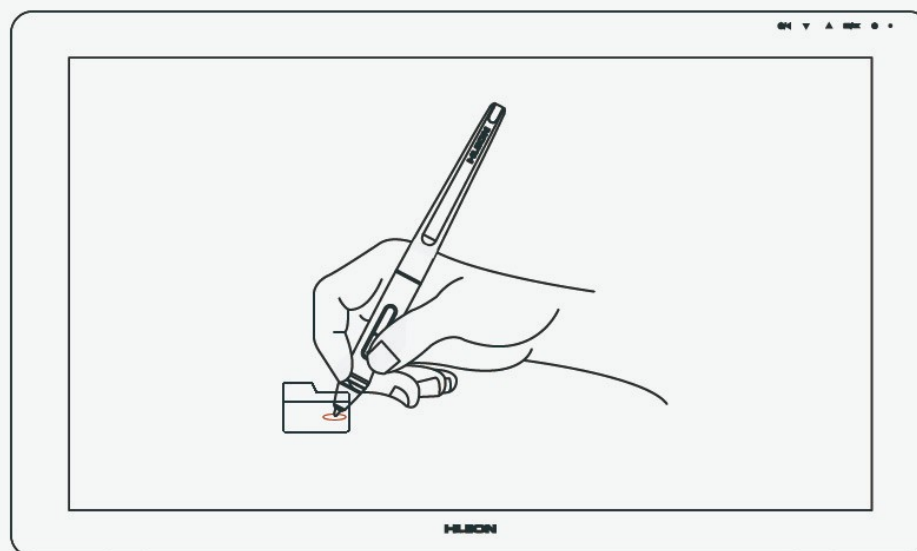

Move

Select the object, then slide the pen tip across the screen to move it.

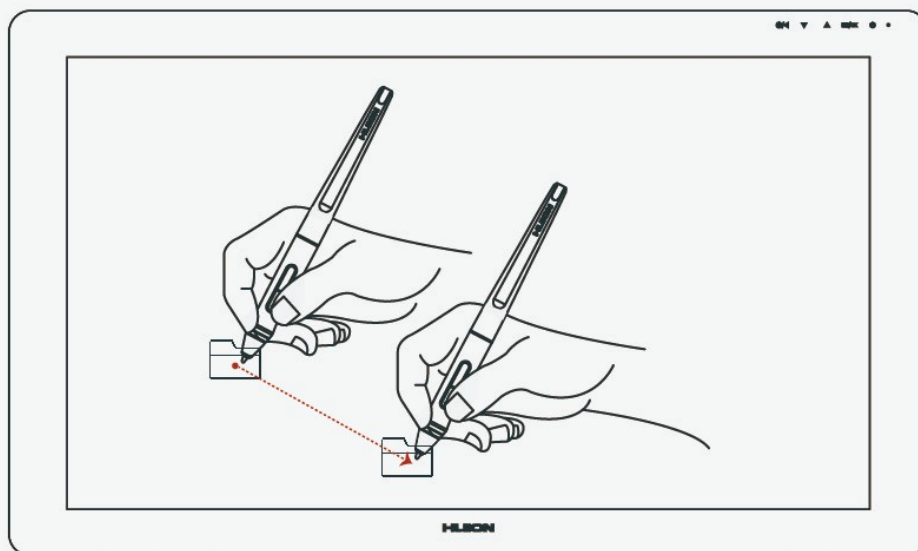

Use the side buttons

The buttons on the pen can be set to two different customizable functions. You can use the buttons whenever the pen tip is within 10mm of the tablet active area. You do not have to touch the pen to the device in order to use the switch.

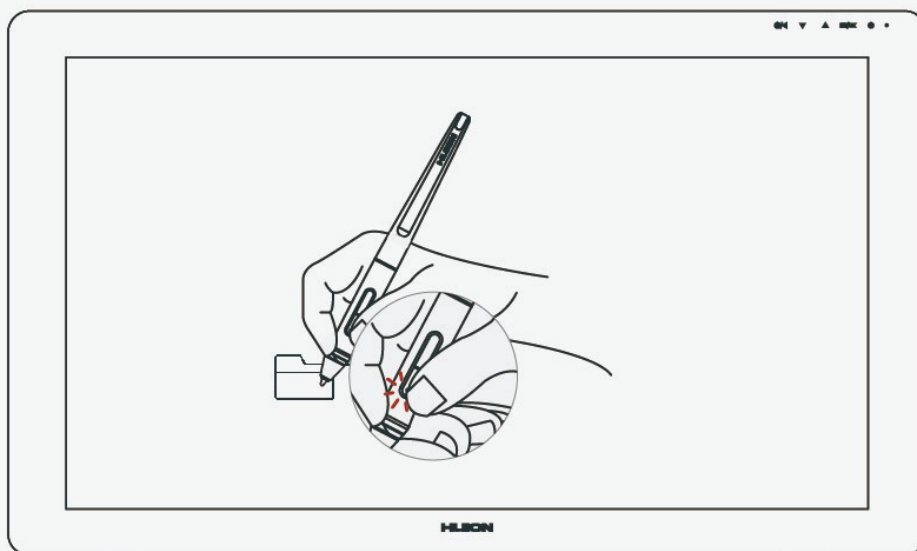

Pen Nib Replacement

The nib will be wear off after using for a long time, then you need to replace a new nib.

1. Anticlockwise rotate the pen holder to open the cover, take a new nib out.
2. Insert the pen nib into the pen nib clip and tilt the pen to pull out the old nib.

3. Insert the new nib straight into the pen and push the nib slowly and firmly until it stops.

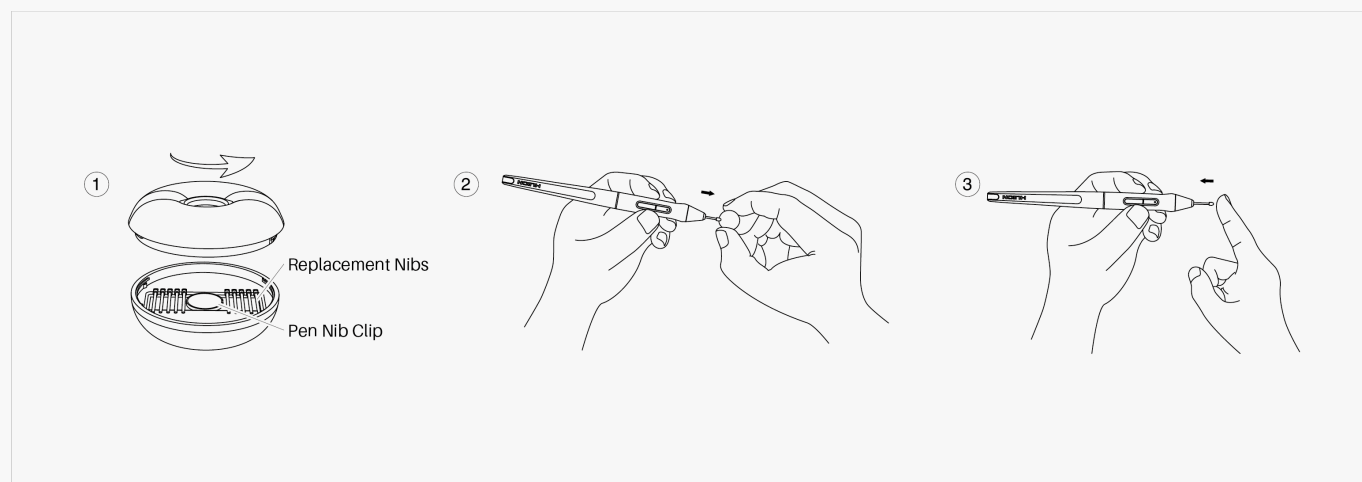

Specifications

Here are the product specifications for you to learn more about the device. If you have any questions, please feel free to contact us.

The following data will vary in different usage environments and are for reference only.

Appearance

Color	Dark Gray
Dimension	604.2 x 358 x 21~28.3mm
Workspace	526.85 x 296.35mm
Net Weight	5.6Kg
Interface	3-in-1 USB-C, Full-Featured USB-C(DP1.2)

Screen

Resolution	2560 x 1440(16:9) QHD
LCD Type	IPS
AG Glass	Anti-glare matte film
Full Lamination	NO
Viewing Angle	89°/89°(H)/89°/89°(V) (Typ.)(CR > 10)
AGamut	85%NTSC/120% sRGB
Display Color	16.7M(8bit)

Technical Specifications

Digital Pen	PW517
Pen Technology	Battery-Free Electromagnetic Resonance
Pen Resolution	5080 LPI
Pressure Sensitivity	8192 Levels
Pen Tilt	Support
Sensing Height	10mm
Report Rate	> 220PPS

Operating Conditions

Input Voltage	DC 19V
Output Voltage	19V 3A
Power Consumption	≤ 20W
Standby Consumption	≤ 0.3W
Working Temp and Humidity	0-40°C, 20-80%
Storage Temp and Humidity	-20°C~60°C, 10-90%

OS Compatibility

Windows 7 or later
 macOS 10.12 or later
 Android 6.0 or later

Troubleshooting Solutions

1. Possible Breakdowns Related to Display.

Power indicator does not flash.

1. Make sure power is on.
2. Check the socket and power cable.

No display on the screen.

1. Make sure power is on.
2. Correctly connect the cables.
3. If you connect the display with a laptop, please make sure the display is on the right display mode: extend or duplicate mode.
4. Check whether the side indicator shows green, if not, it means no signal in. Please reboot your computer or reconnect the cable.
5. Is the signal wire broken or bent? If so, please replace the signal wire.

No signal.

1. Make sure the cables are well connected.
2. If you use a desktop, make sure the HDMI port is plugged into the graphic card on the tower, but not into the motherboard.
3. If you use a Windows OS computer, make sure to press "Windows+P" on keyboard, then choose Duplicate or Extend. Don't choose Computer Only or Projector Only.
4. If there is no HDMI port on your computer, you need an extra HDMI adapter. We don't recommend a USB to HDMI adapter. Also, we don't recommend a USB hub. We recommend DVI/ VGA/ Display Port/ Type-C/ Thunderbolt, etc. to HDMI adapters.

Images are blurred.

Please set the display resolution with 1920 x 1080.

Displays wallpaper & task bar of computer monitor only.

1. It is because you are under extended mode right now. It is a normal situation.
2. If you are not familiar with extended mode, we recommend you to use in Duplicate/Mirror mode. Windows OS: Press keyboard combination---Windows+P---then choose Duplicate

Mac OS: System Preference---Displays--- Arrangement--- Check "Mirror Displays".

3. If you decide to use in Extended mode. Make sure to choose pen display as Work Area in

Driver. It is usually "Display 2".

Lack of colors.

Check the pins of the signal wire are not bent or fractured.

There is chromatic aberration.

As the regional color temperature is different, so minor chromatic aberration is a normal phenomenon.

Images jitter or ripple images appear.

It is likely that there is electric equipment nearby that brings about electronic interference.

2. Possible Breakdowns Related to Functions.

There is no pressure in the graphics software but the cursor moves.

You may have installed other display drivers or opened the drawing software when installing the driver. Please uninstall all drivers and close the drawing software, then reinstall the Huion driver. It's better to restart your computer after finishing the installation.

The pen does not work.

1. Make sure you are using the pen that originally came with your tablet.
2. Make sure you installed the driver correctly.

Press Keys does not work.

1. Make sure the Press Keys function were enabled in the driver.
2. Make sure you have correctly defined the Press Keys.
3. Check if the press lock switch is on the unlock position.

The computer can't enter sleep mode.

When you are not using the display, please do not put the pen on the display surface, which will keep the computer awake.

The side button of the pen doesn't work.

When pressing the side button, please make sure that the nib didn't touch the tablet surface and the distance between the nib and surface is within 10mm.

The computer can't recognize the display.

Check that the USB port is normal. If there is any problem, please use another USB port.

If your problem is not resolved, please click [FAQs](#) to view more troubleshooting methods or email us(service@huion.com).