Contents

Product Overview	2
Tablet Introduction	2
Product and Accessories	3
Product Connection	5
Driver and Setting	8
Install Driver	8
Driver Interface Preview	10
Pen Tablet Setting	11
Digital Pen Setting	18
Driver Setting	23
Diagnose	27
Digital Pen Basic Operation	31
Specifications	35
Troubleshooting Solutions	36

Product Overview

Tablet Introduction



Thanks for choosing HUIION INSPIROY Keydial creative pen tablet. This is a new generation of professional battery-free drawing tablet, which can greatly improve your work efficiency of painting and creation, and full of fun. You can freely painting and writing, depicting different lines and colors, just as the pen writes on the paper, which brings you a real shock experience.

To give you a better understanding and using of your tablet, please read this user manual carefully. The user manual only shows the information under Windows, unless otherwise specified, this information applies to both Windows and Mac systems.

Note: The pictures in the User Manual are for reference only.

Product and Accessories

Please see the detailed product introduction.

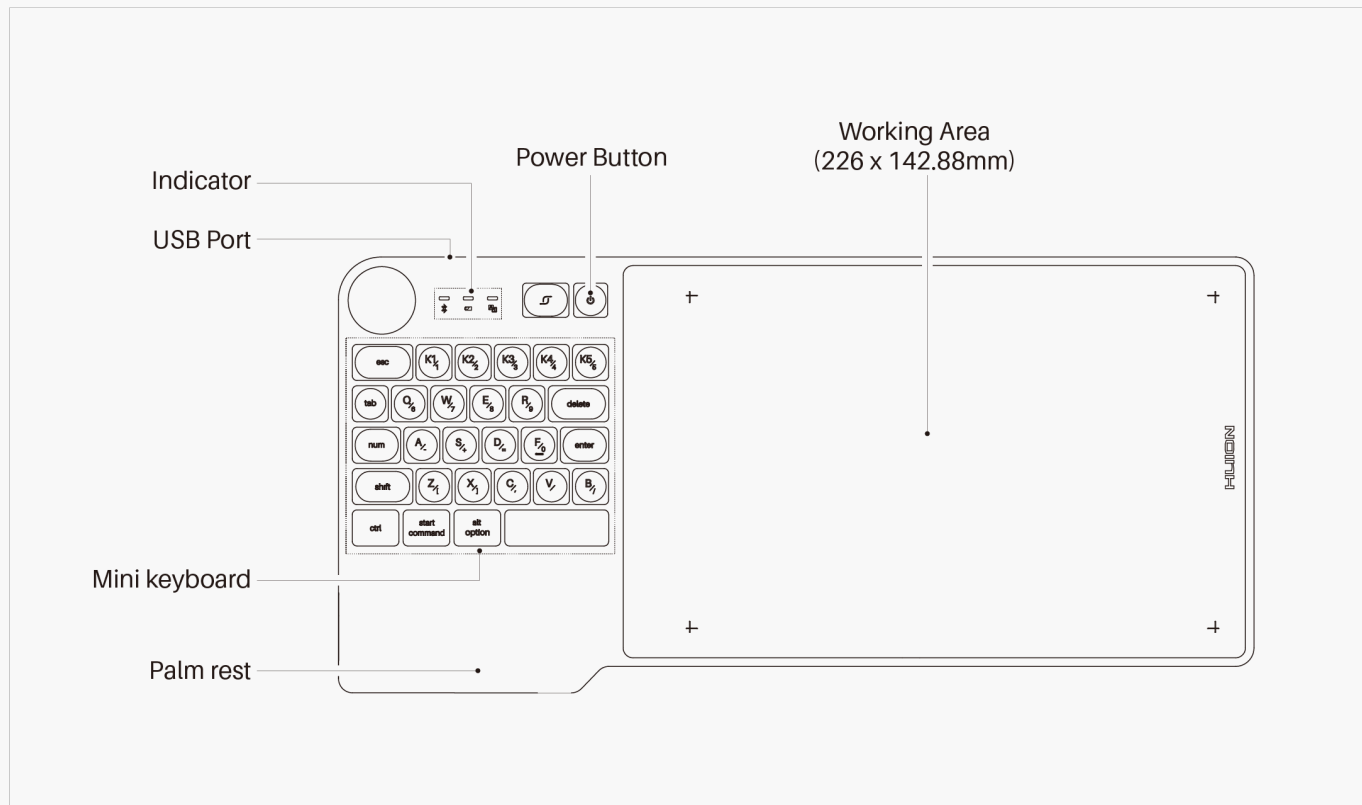

*Press Keys

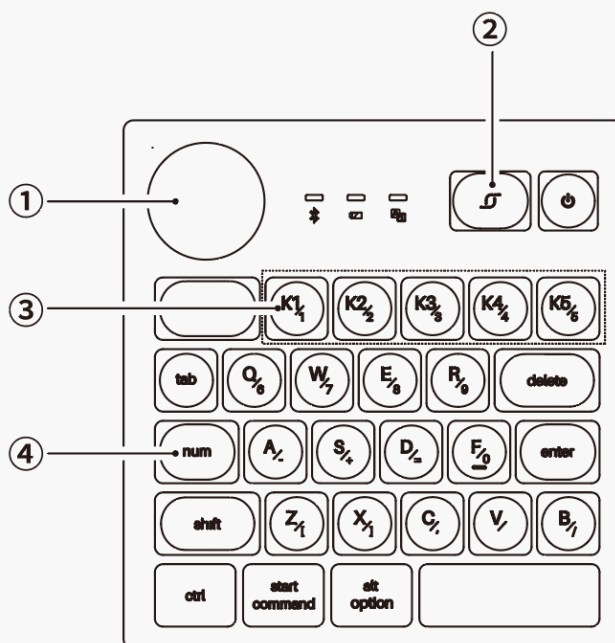

1. Dial: While the Dial mode, features are programmable, with default functions being canvas size adjustment, brush size adjustment and canvas scrolling.
2. Long press to call up the function menu /Serve as Enter Button.
3. Press keys that are programmable on the driver.
4. Num Key: Switch the alternative functions of keys.

After unboxing your package, make sure that you have the following items:

Tablet*1

Battery-free Pen*1

Pen Holder*1

Replacement Nibs(Inside the Pen Holder)*10

USB Cable*1

Quick Start Guide*1

Warranty Card*1

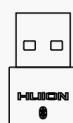
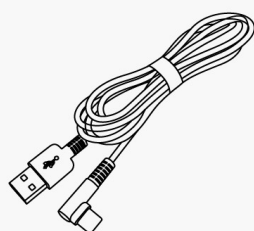
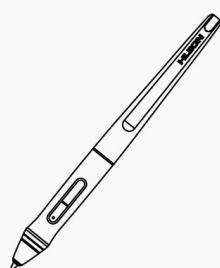

Product Connection

The tablet supports the connection of a computer and a mobile phone.

Wired Connection, Bluetooth Connection and Navo Receiver Connection.

Importantly, you can judge the status of the device by observing the color of the light.

Indicator	Color of light
-----------	----------------

Status of Mini keyboard	
-------------------------	--

Bluetooth indicator	Flash Blue Light
---------------------	------------------

Pairing	
---------	--

	Blue Light
--	------------

Bluetooth Paired	
------------------	--

Battery indicator	Flash Red Light
-------------------	-----------------

Low Battery	
-------------	--

	Red Light
--	-----------

Charging	
----------	--

	Green Light
--	-------------

Charged	
---------	--

Num indicator White Light

Alternative Functions of Keys are Activated

1. Wired Connection

Connect the tablet to your computer with USB cable. Please follow the steps below:

1. Take out the USB cable from the package, then connect tablet to your computer.
2. Please download the Pen Driver from our website:Driver-KD200.
3. Open the driver interface, the device picture will be displayed on the interface, indicating that the tablet is successfully connected to the computer.You can start use the tablet.

[See Section](#)

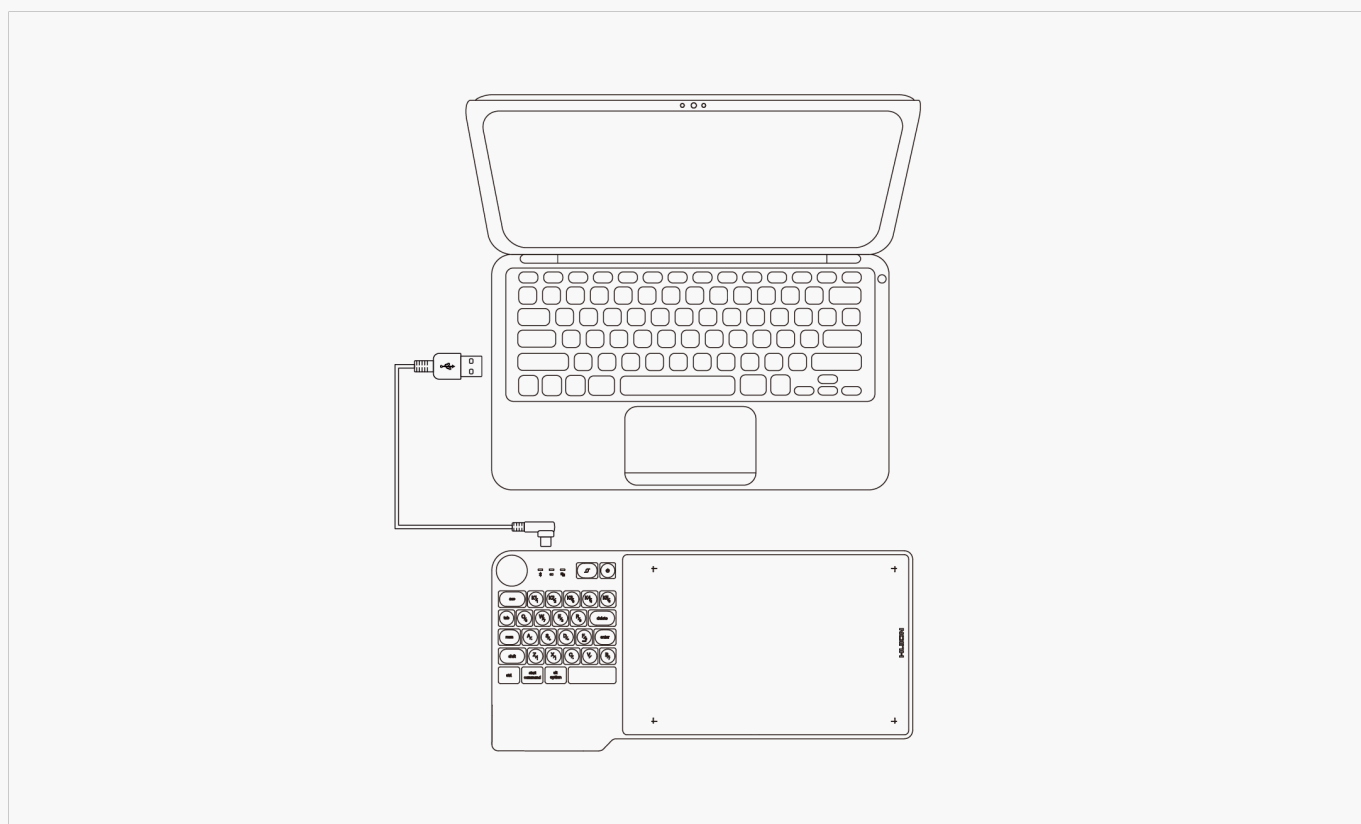

2. Bluetooth Connection

PC and Android devices are supported to be paired with Bluetooth. Please follow the steps below:

1. Activate Bluetooth on PC or any Android device.
2. Long press the power button for 2 seconds till the blue light flashes to power on the pen tablet.
3. Have the device Inspiroy Keydial connected via Bluetooth pairing, Please hold the key combos Shift+Ctrl+Start Command to adjust the imaging on your phone in case of display distortion.

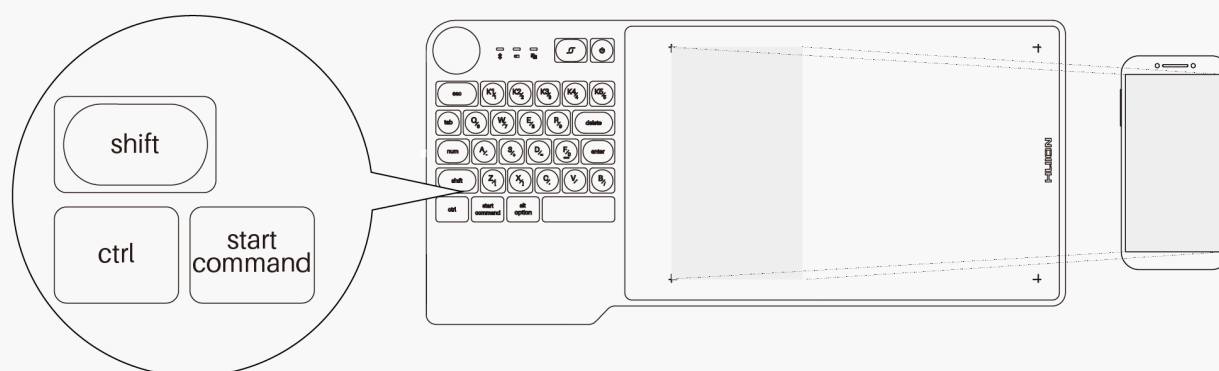

3. Nano Receiver Connection

A nano receiver is available for PC without Bluetooth. Please follow the steps below:

1. Long press the power button for 2 seconds till the blue light flashes to power on the pen tablet.
2. Insert the nano receiver into the PC and a blue light will be on to indicate the connection success.

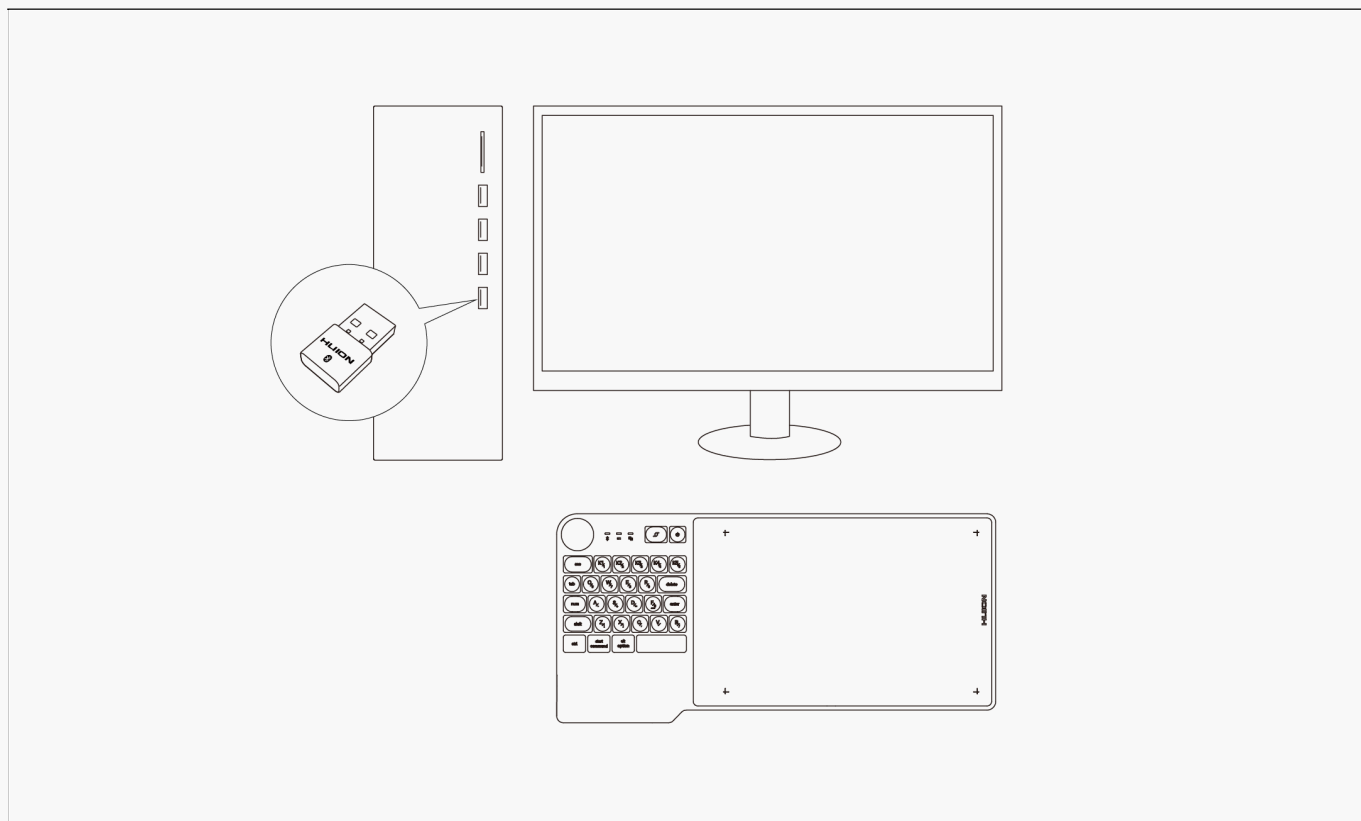

Driver and Setting

Install Driver

1. Please choose the correct driver for your device from our website: [Driver-KD200](#).
2. Click [Driver-KD200](#) to download it.
3. Follow the instructions to complete the installation.

Note:

1. Before installing driver, please close all graphic software and antivirus program.
2. If you have installed other pen tablet driver, please uninstall it before you install this driver.
3. Please make sure your computer OS are as following: Windows 7 or later, macOS 10.12 or later.
4. Run the tablet driver program and complete the installation according to the instruction.

After the download is successful, double-click to open the driver, Connect the device to your computer.

If the connection fails, please reconnect the computer to the device, or restart the driver or computer.

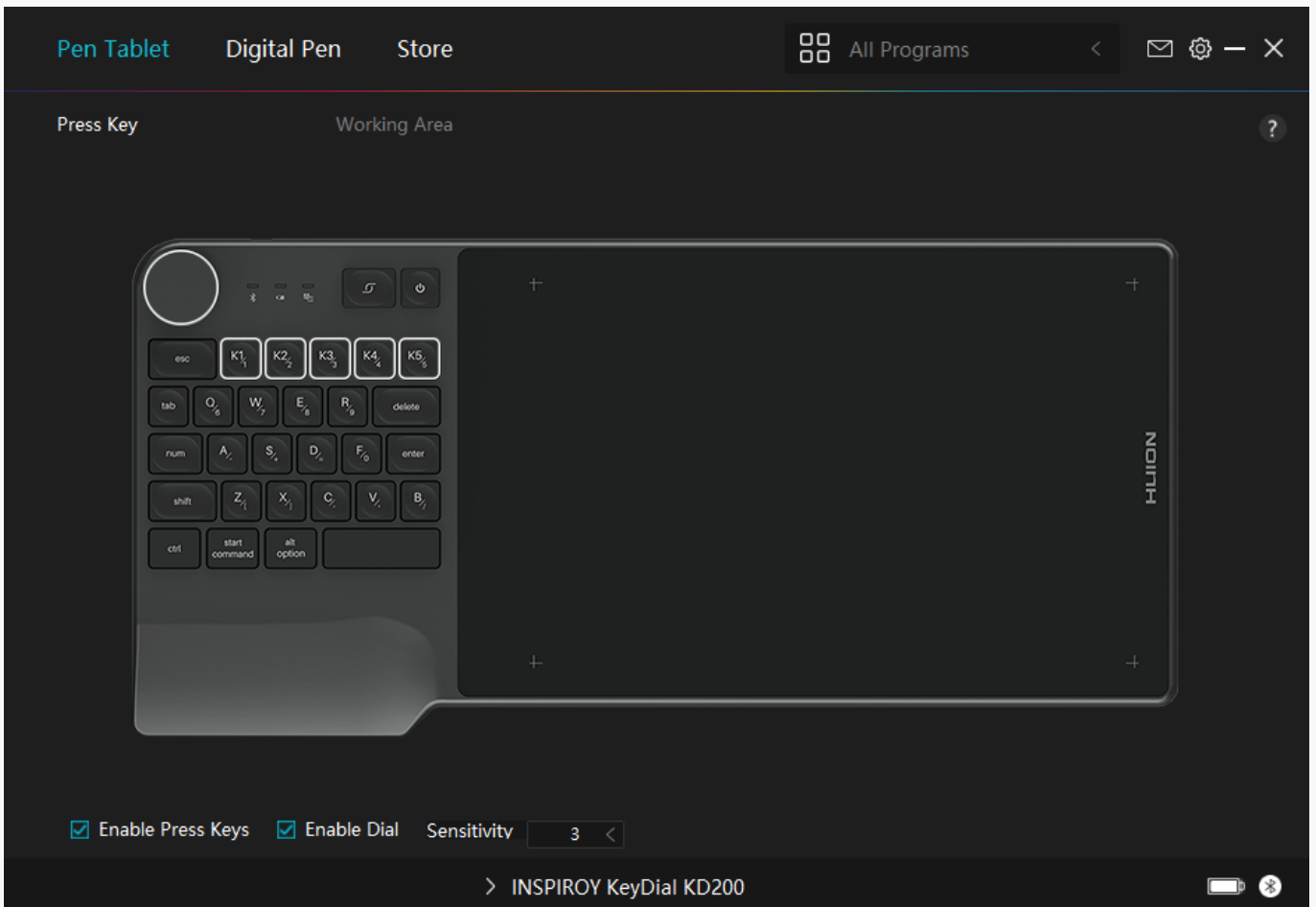
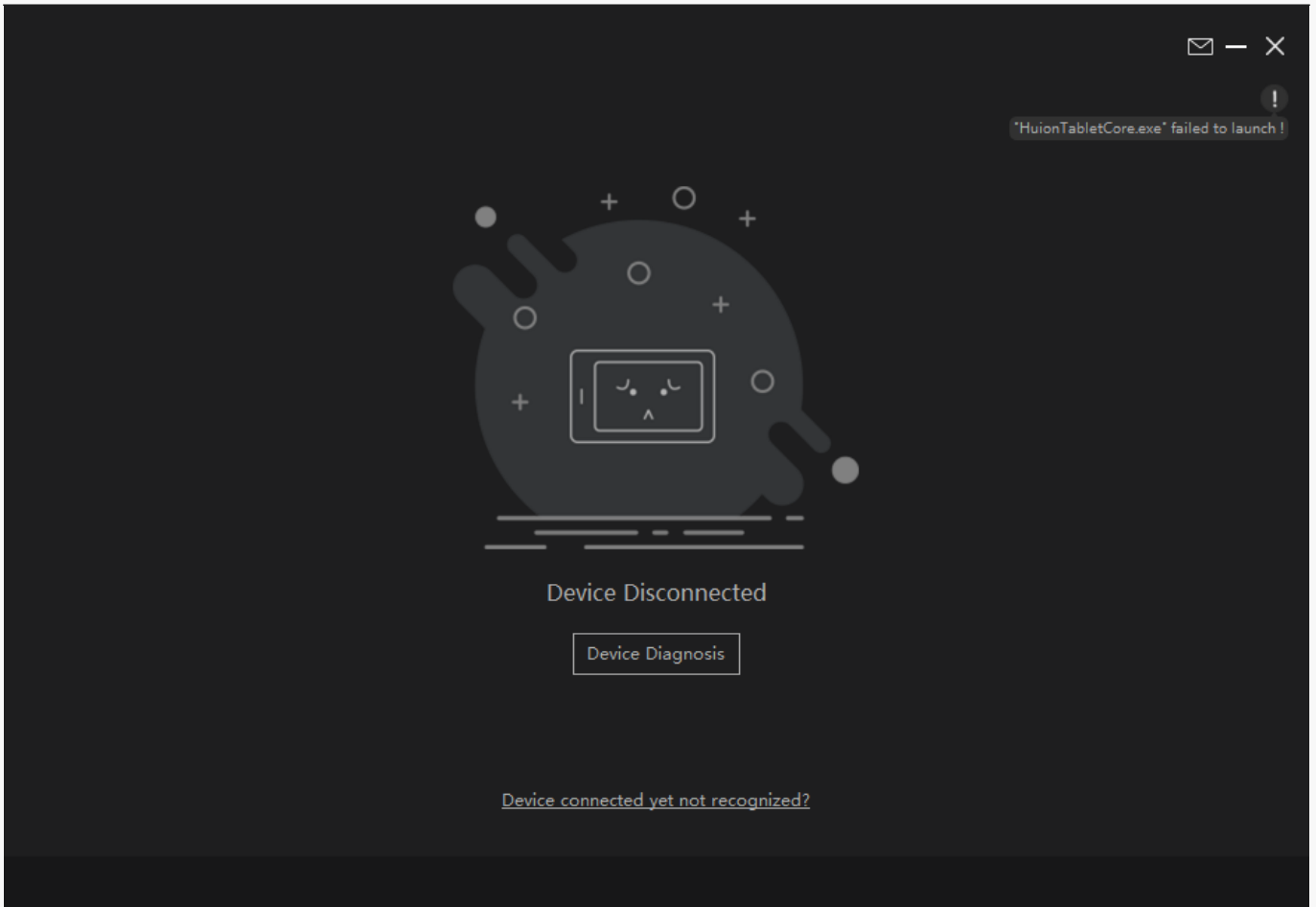

Driver Interface Preview

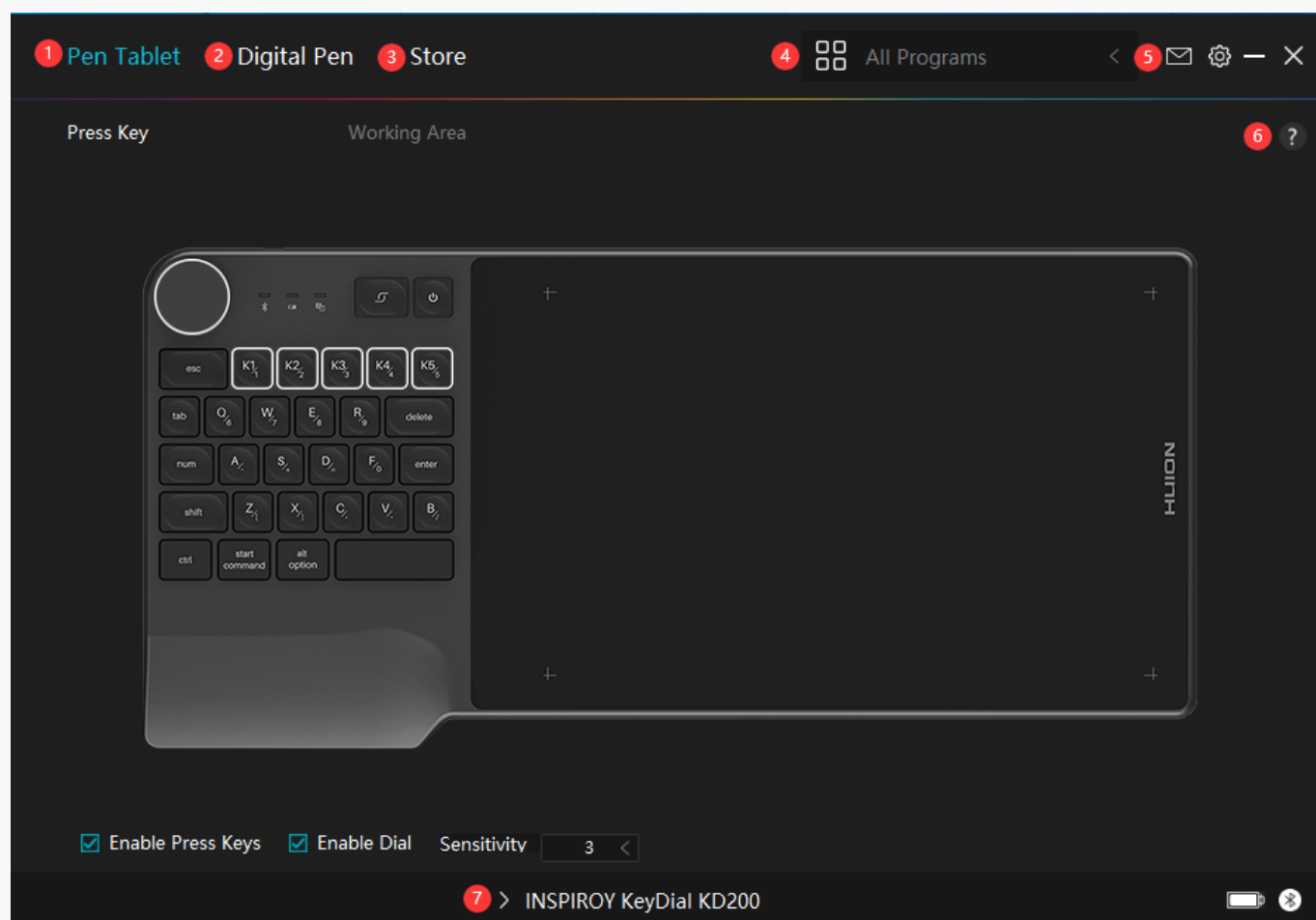

1. Pen Tablet

Pen Tablet function setting interface, the users can set the tablet function on this interface, such as Press Key, Dial and Working Area.

[See Section](#)

2. Digital Pen

The users can set the Pen function on this interface. About Press Key, Mode selection, Pressure Sensitivity Adjustment and Pressure Test.

[See Section](#)

3. Store

Huion Store is where you can get the latest information about the product such as its FAQ or sales promotion. In addition, you can also purchase Huion's other products or accessories here.

4. Add Programs

1. Some programs which have already been opened will appear for you to choose from after clicking Add a Program on the screen. For more programs, click Browser and choose the item that you want to get it added.
2. You can set different functions for different programs. Functions of the press keys change automatically as you switch from one program to another.
3. When you select All programs, the functions of press keys that you set are valid for every program. By clicking Add a Program from the drop-down list, you can set the functions for a specific program and hence have unique settings for different programs. After that, when you launch a specific program, the Driver will automatically recognize it and the setting features will change to its corresponding ones.

5. Setting

Users can set the functions of a driver on this interface, including check out Device information, Backup setting, General setting, Diagnose, and its version.

[See Section](#)

6. Common Problems

Click "?" and jump to Forum in our website <https://support.huion.com/en/support/home> to get a user manual and feedback.

7. Switch between Devices

The Driver is able to support two devices at most. Functions of them can be customized by users respectively. When switch to one of them, functions change to its corresponding ones.

Pen Tablet Setting

Press Key

You can customize the functions of these press keys according to your own habits, and you can uncheck "Enable press keys" in the lower left corner to turn off these functions. Place the cursor over one of the buttons on the screen of your computer to check its default value. Click a button and then a pop-up dialog box appears. Choose what you want and set its function.

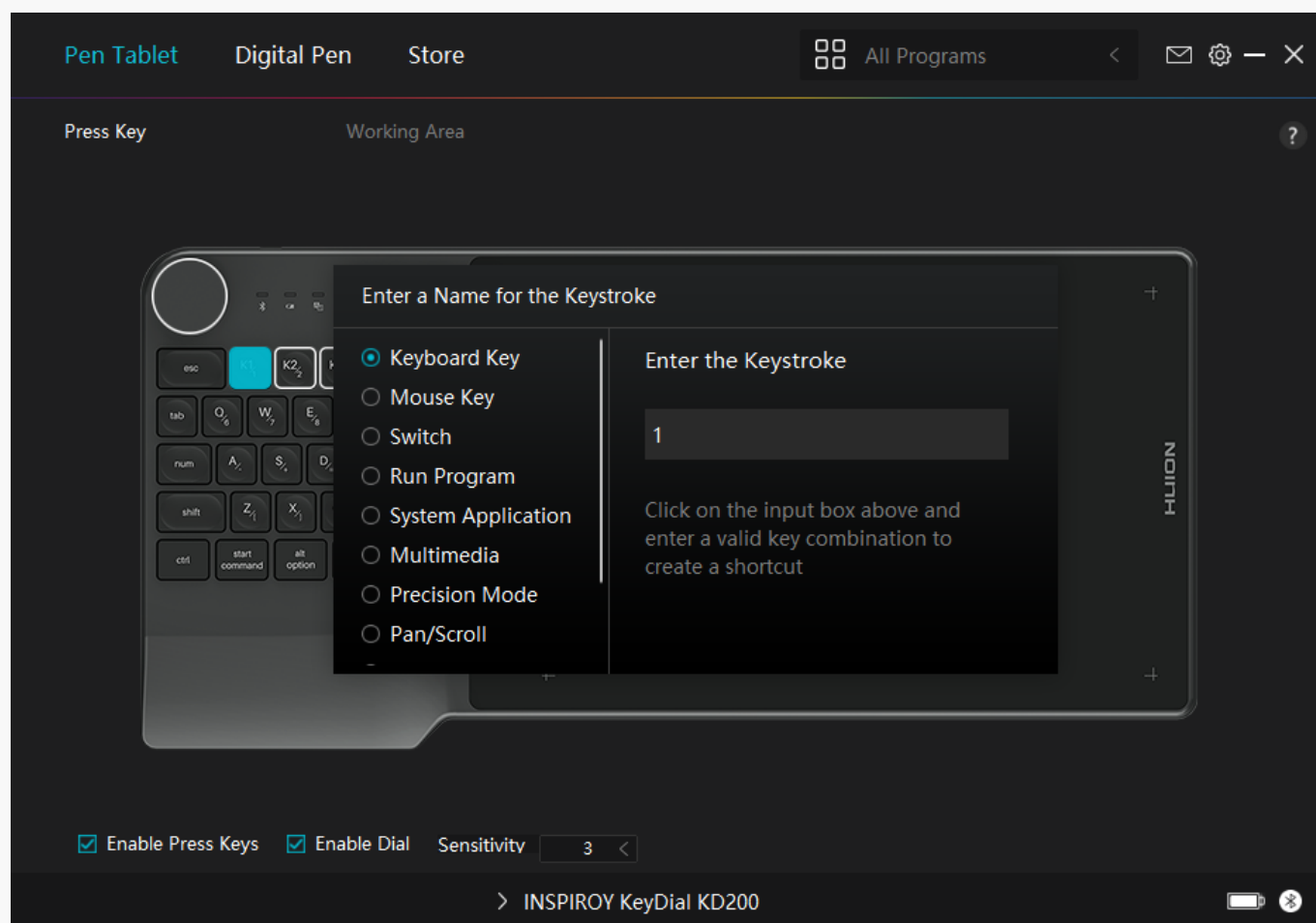

Refer to this table of settings below to help you decide if you want to change any settings that are already assigned.

Note: The performance of functions in the table below is up to the device that users have connected.

Keyboard Key	Click on the input box above and enter a valid key combination to create a short
Mouse Key	Select the functions of a Mouse or Wheel. Please see the picture below for detail Right Button, Middle Button, and Double-left Click. Wheel: Wheel Forward and W
Switch	Select among Switch Screen, Switch Brush, Mouse Mode On/Off, and Game Mod

Run Program	Click Browse and select the program that you want to run quickly. After that, pre
System Application	You can apply these functions to press keys: Lock the Screen, Sleep, Power Off,
Multimedia	You can apply these functions to press keys: Previous Song, Next Song, Play/Paus
Precision Mode	You can toggle between normal precision and a precision that you choose, from appears, move the slider to set the precision that you toggle into. For example, if press the pen button, you switch to working in the precision that you selected fro you switch back to working in the normal precision. Press "Esc" to exit Precision
Pan/Scroll	This function allows you to pan and scroll in a document or item by moving the p Pan/Scroll, the Scroll Speed window appears. Move the slider to your preferred s
Quick Menu	Pick it up and you can use the key to pull up the Quick Menu. Detailed informatio
Fixed Pressure Sensitivity	You can lock the pressure at the current level until you release the component. F you can paint with pressure sensitivity enabled in your application until you reac button to lock in that brush size as long as you are pressing and holding the butt
None	When select None, the keys will have no function.

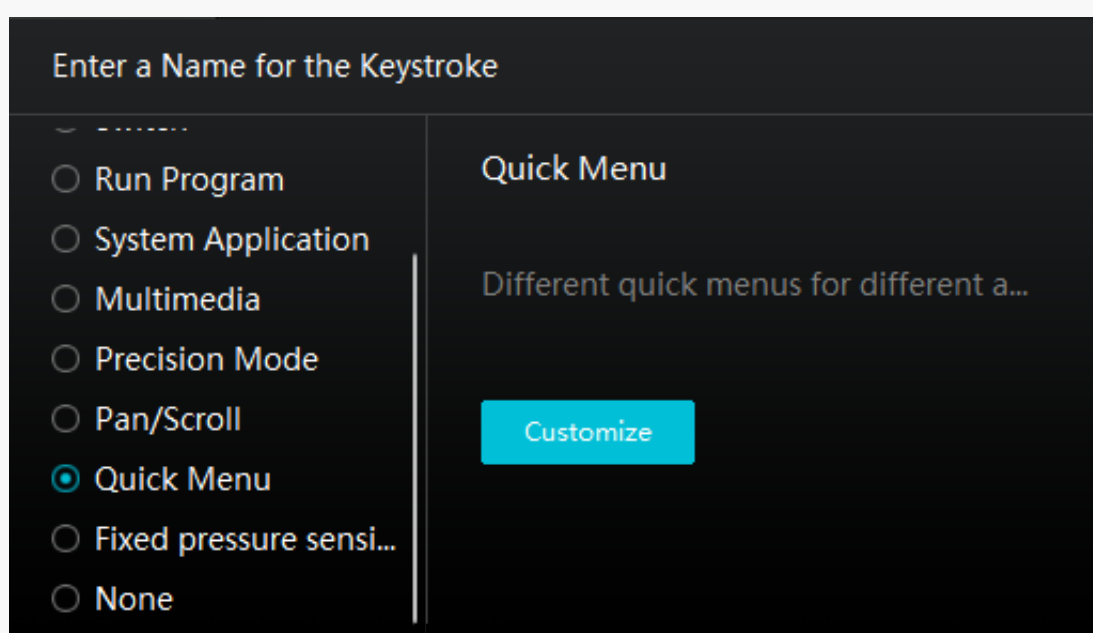

... (see picture 1). For each of the six buttons on the left, users can enter a name for it and set its unique function. After that, users can call up the Quick Menu by pressing the key (see picture 2). The menu disappears after a click on any of the six buttons. By clicking "Fix" once the menu will be fixed on the desktop while after a second try the "Fix" button changes to "Close" and the menu disappears (see picture 3). Put the cursor on the menu to drag it.

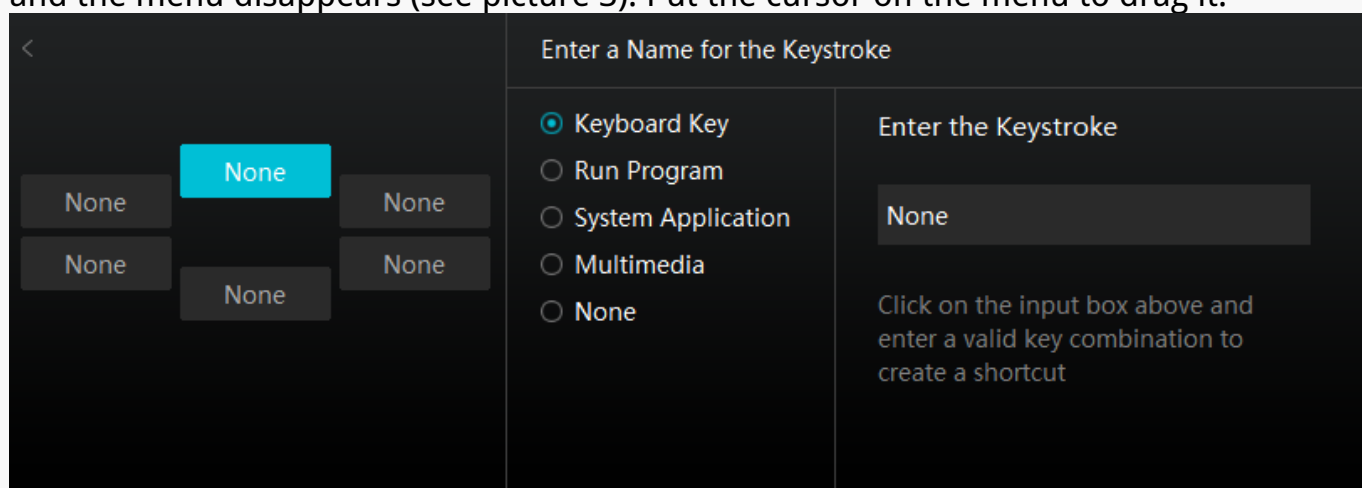

picture 1

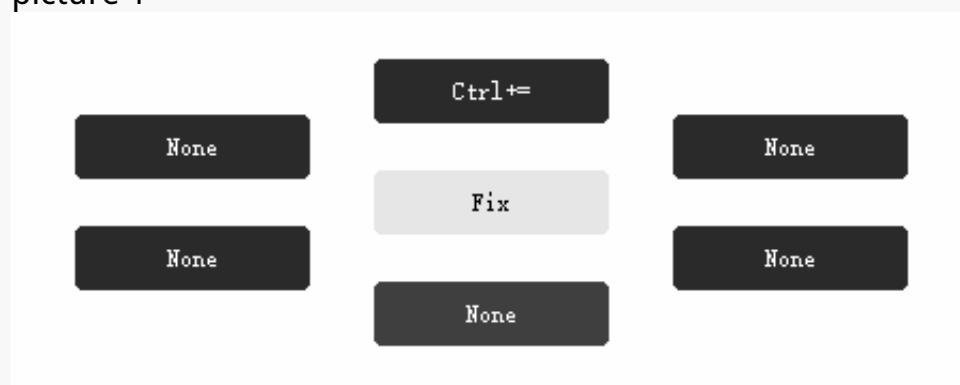

picture 2

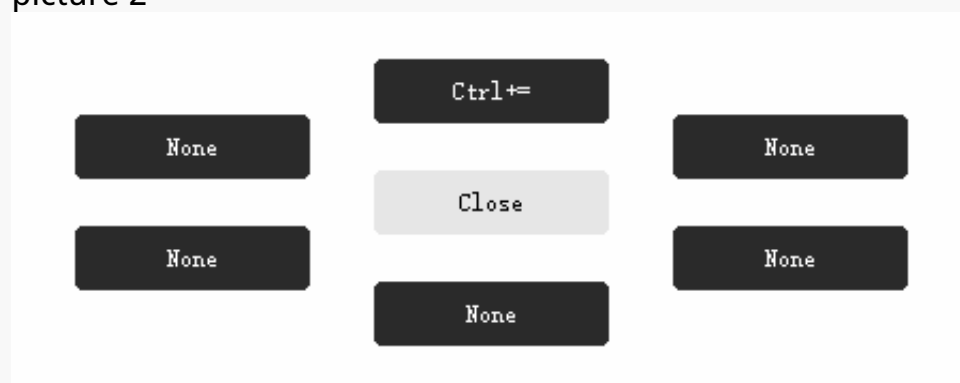

picture 3

Working Area

Select the Working Area tab to define the relationship between pen movement on the tablet and cursor movement on the monitor screen.

By default the entire active area of tablet maps to the entire monitor. If more than one monitor is in use and you are in extended mode, you need to choose the related monitor on the driver interface which you are going to map to.

If your monitors are in mirror mode (All monitors display the same content), the tablet maps to the entire space on each monitor and the screen cursor is displayed on each monitor simultaneously.

1. Working Area Setting

Define the pen tablet area that will be mapped to the screen. Three modes on the driver can be chosen:

[1] Full Area: The default setting is the entire active area of the pen tablet.

[2] Screen Ratio: The ratio of the active pen tablet area depends on that of the display device, which as a general rule, is 16:9. In Screen Ratio mode, these two ratios keep the same.

[3] Custom Area:

1> Enter coordinate values.

2> Users can adjust the working area of the pen tablet by changing the outlines of the smaller rectangle (see picture 1). Users can also drag the two blue rectangles to select the active areas of the digital pen on the screen and the pen tablet. (see picture 2 and 3).

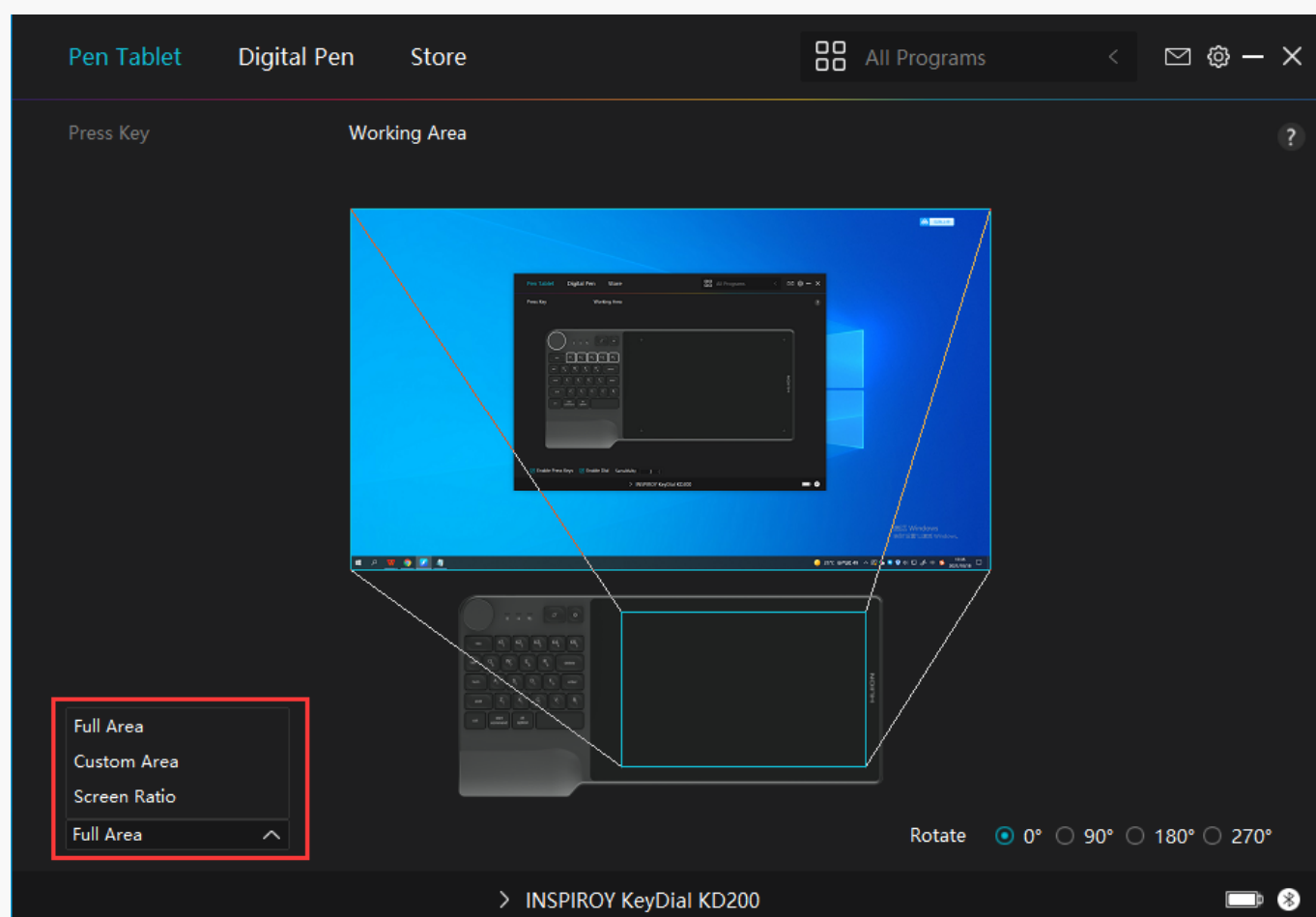

picture1

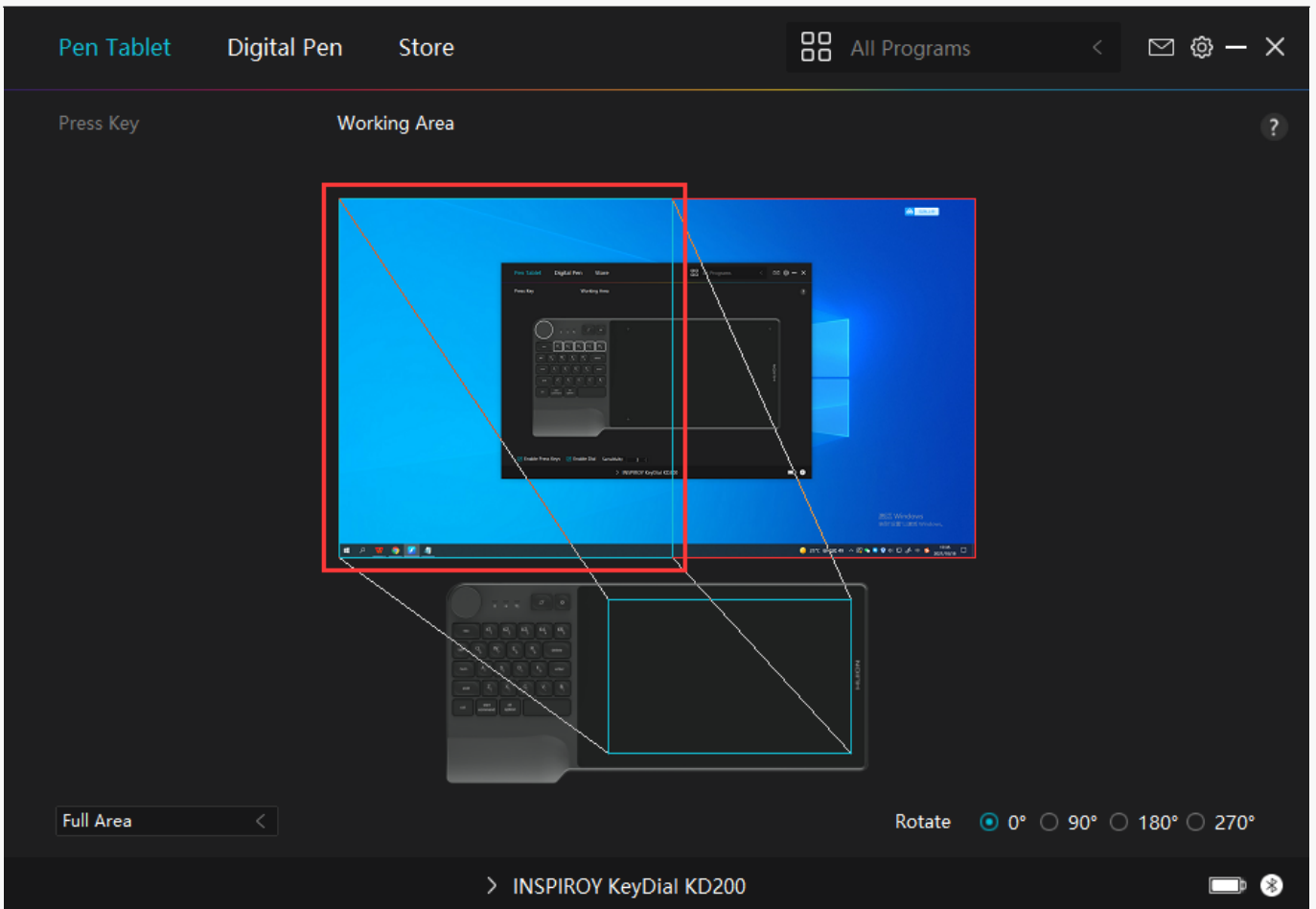

picture2

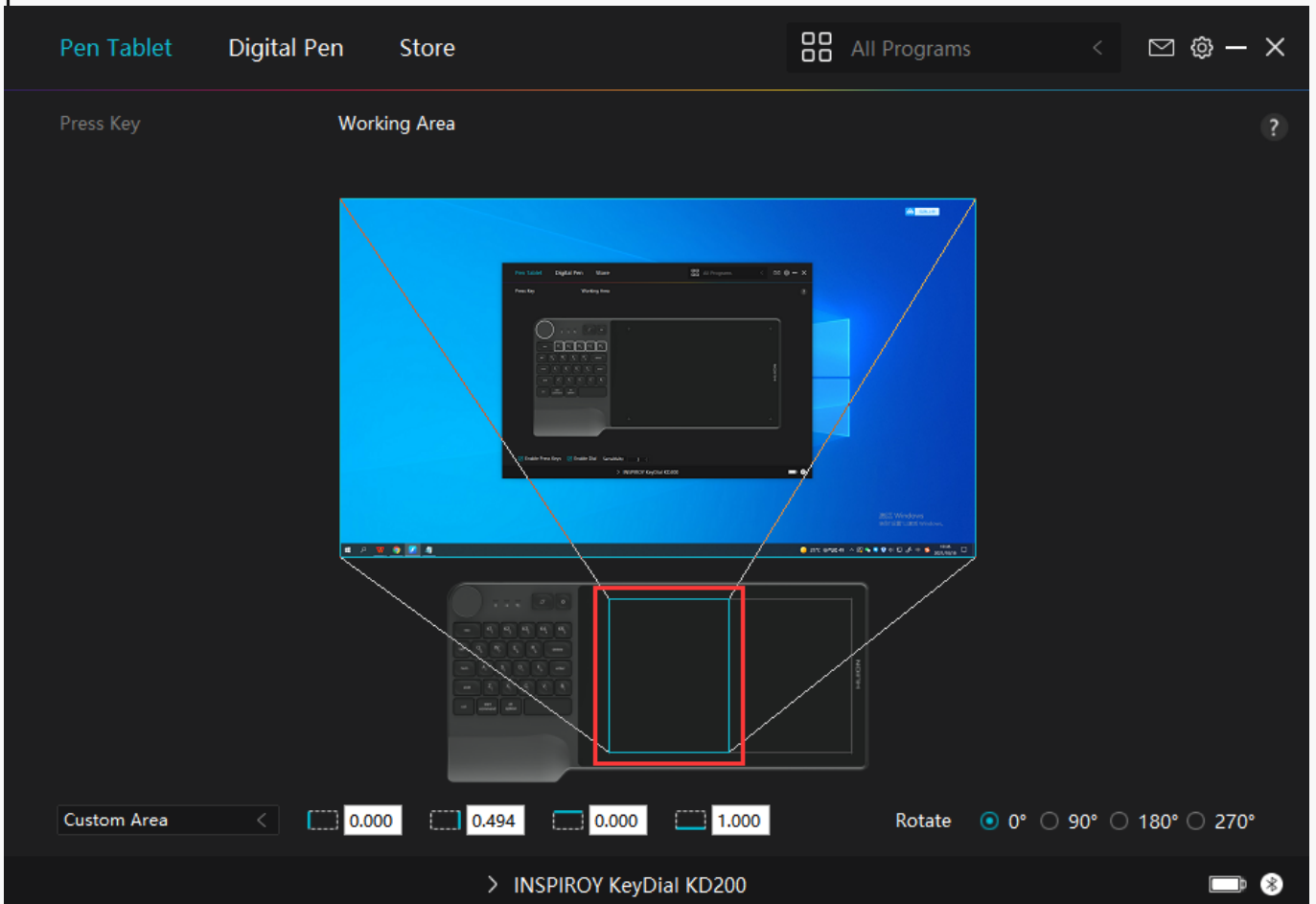

picture3

2. Rotate Working Area

By changing the direction of the tablet to adapt to the left and right hand operation. You can rotate the tablet by 0°,90°,180° or 270°.

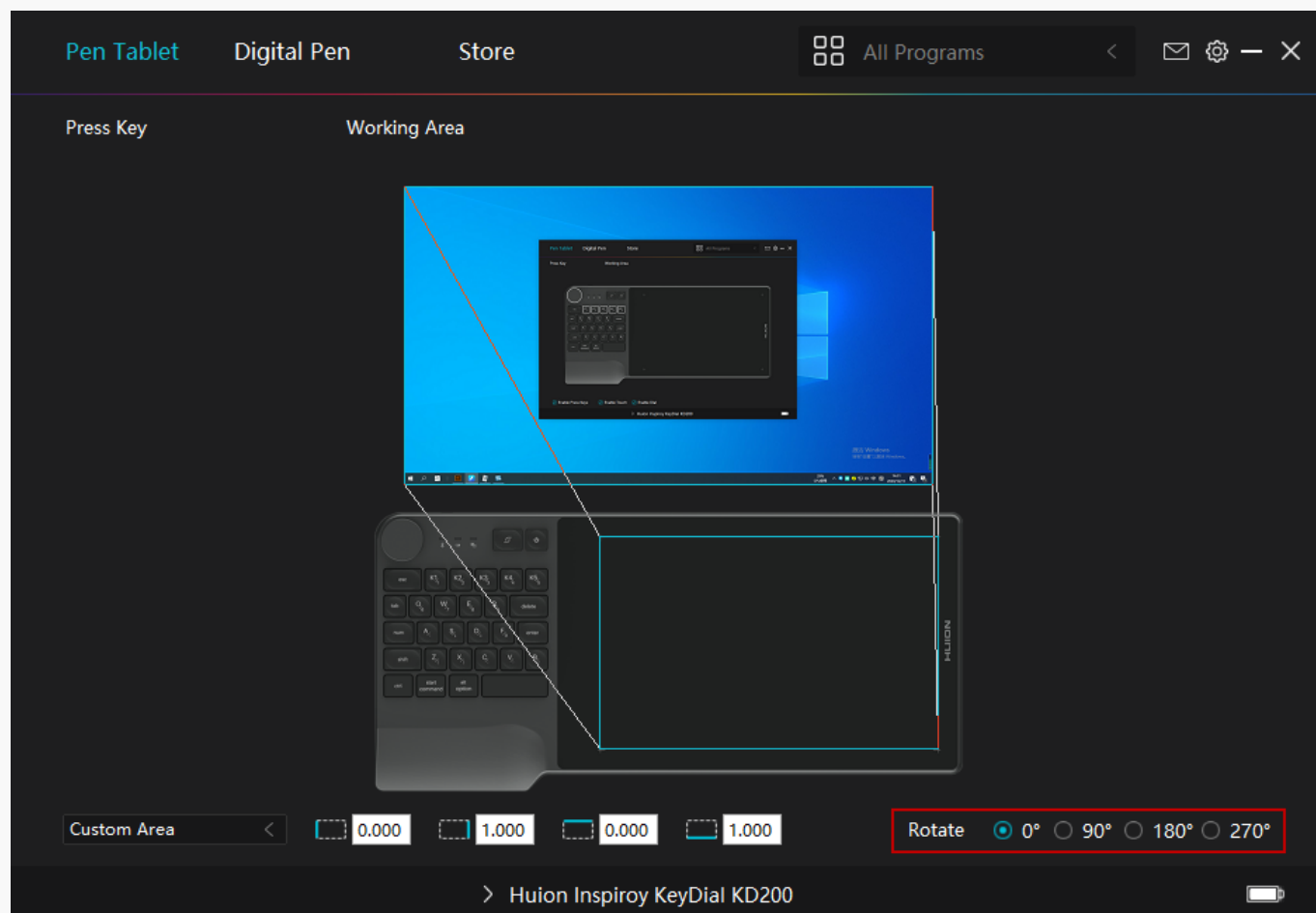

3. Dial Function Setting

Click the Dial to set the function of the dial controller. The default functions are "Zoom in/out", "Adjust Brush Size", and "Scroll Up/Down". Click anyone of the three to change its function within four groups: Default, Multimedia, Customize the Feature, and None.

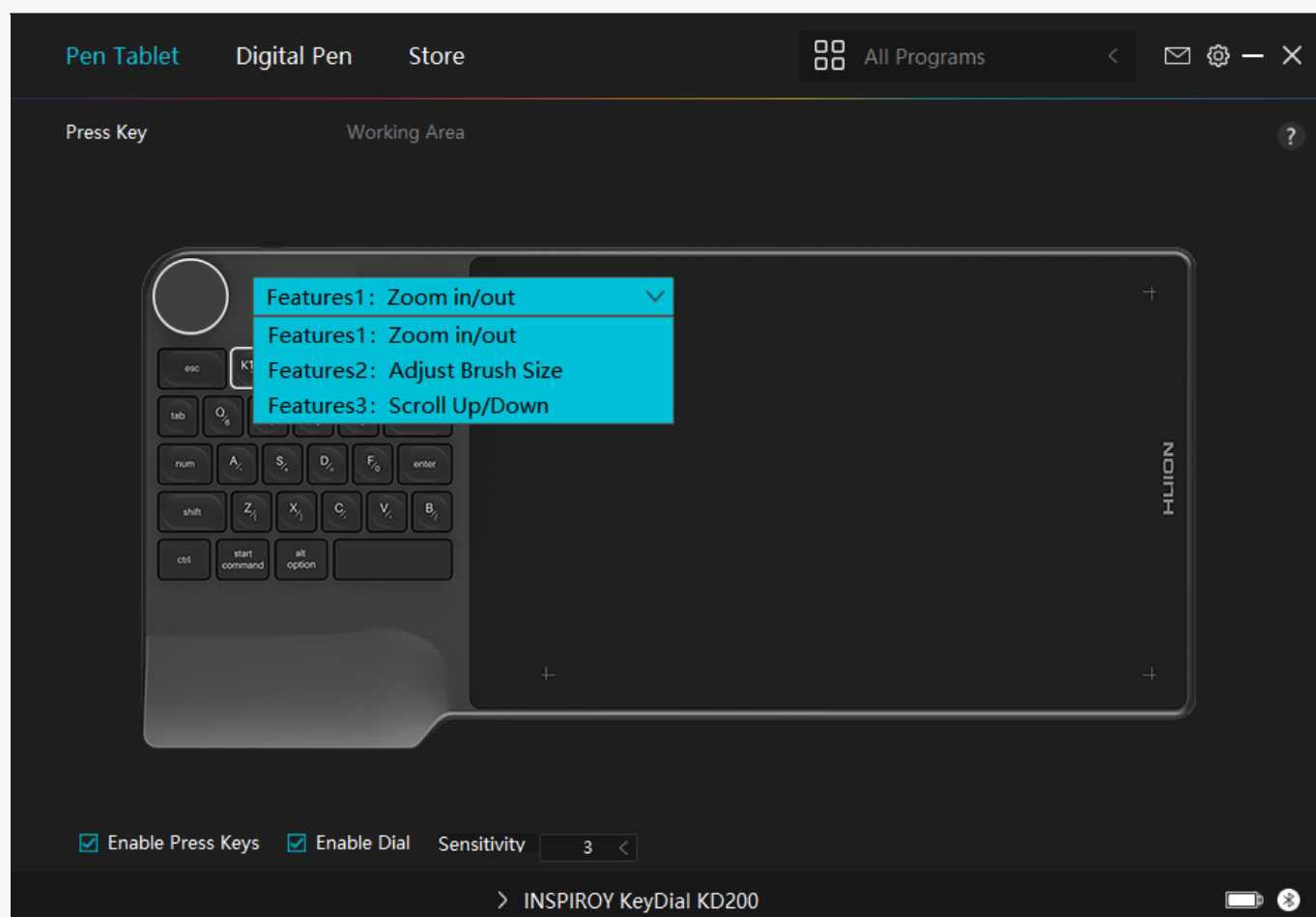

Refer to the table below to get detailed information of the functions.

Default	Functions include Zoom in/out, Adjust Brush Size, and Scroll Up/Down.
Multimedia	Functions are Previous Song/Next Song and Volume Settings.
Customize the Feature	Click on the input boxes (Clockwise and Anticlockwise) and enter valid key to implement the settings.
None	When select None, the dial controller will have no function.

Digital Pen Setting

1. Press Key

You can use this digital pen to interact with your device, drawing, writing, moving files, or activating the functions of pen press keys.

The setting of the pen press keys is the same as the Press Key Setting of the tablet. Please refer to it. [See Section](#)

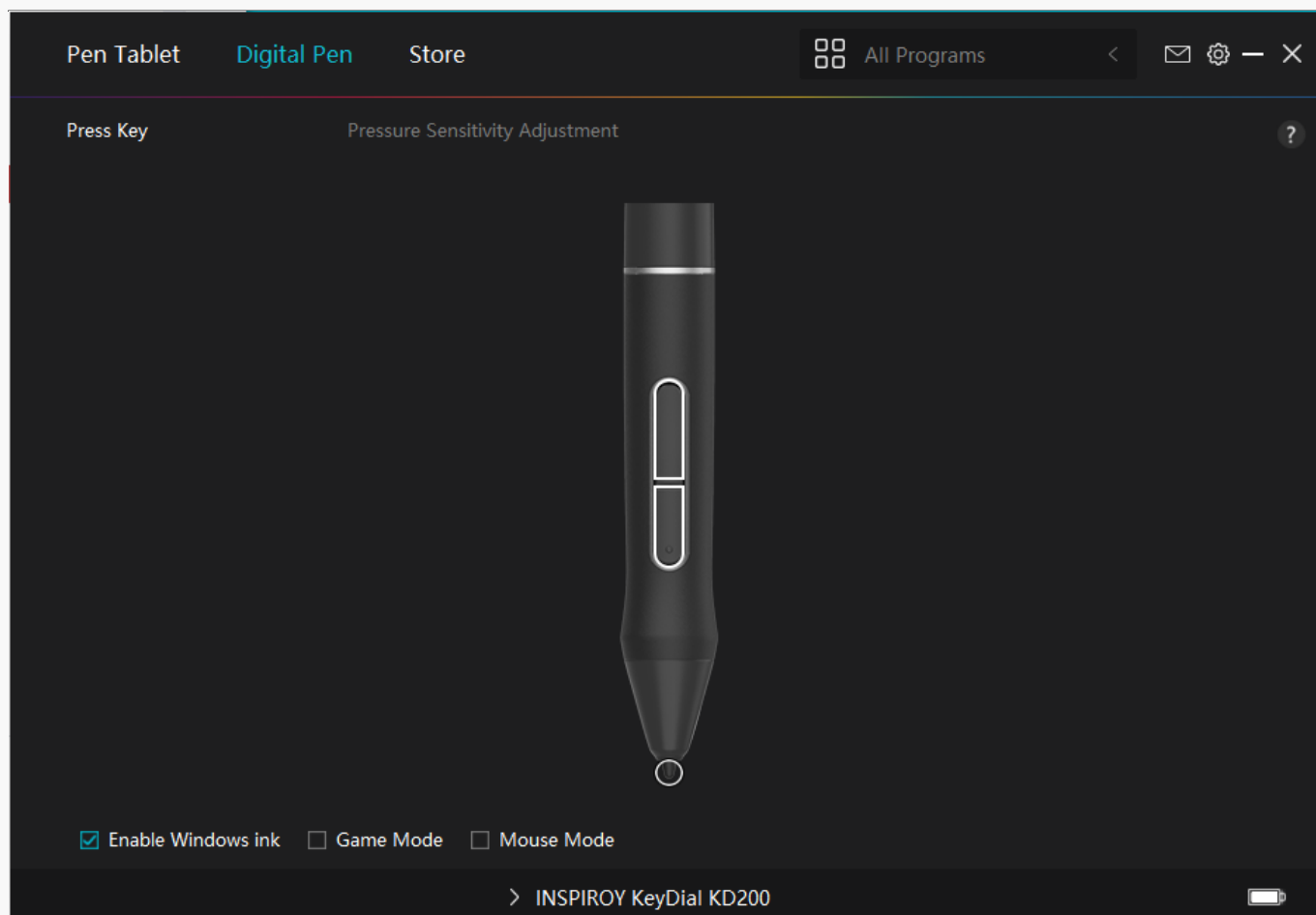

2. Pen Nib Activity

The pen nibs can be set to be Valid/Invalid as needed. Click the drop-down option to select. In Valid mode, the digital pen can be used normally. In Invalid mode, the digital pen has cursor movement, but cannot complete the specified action.

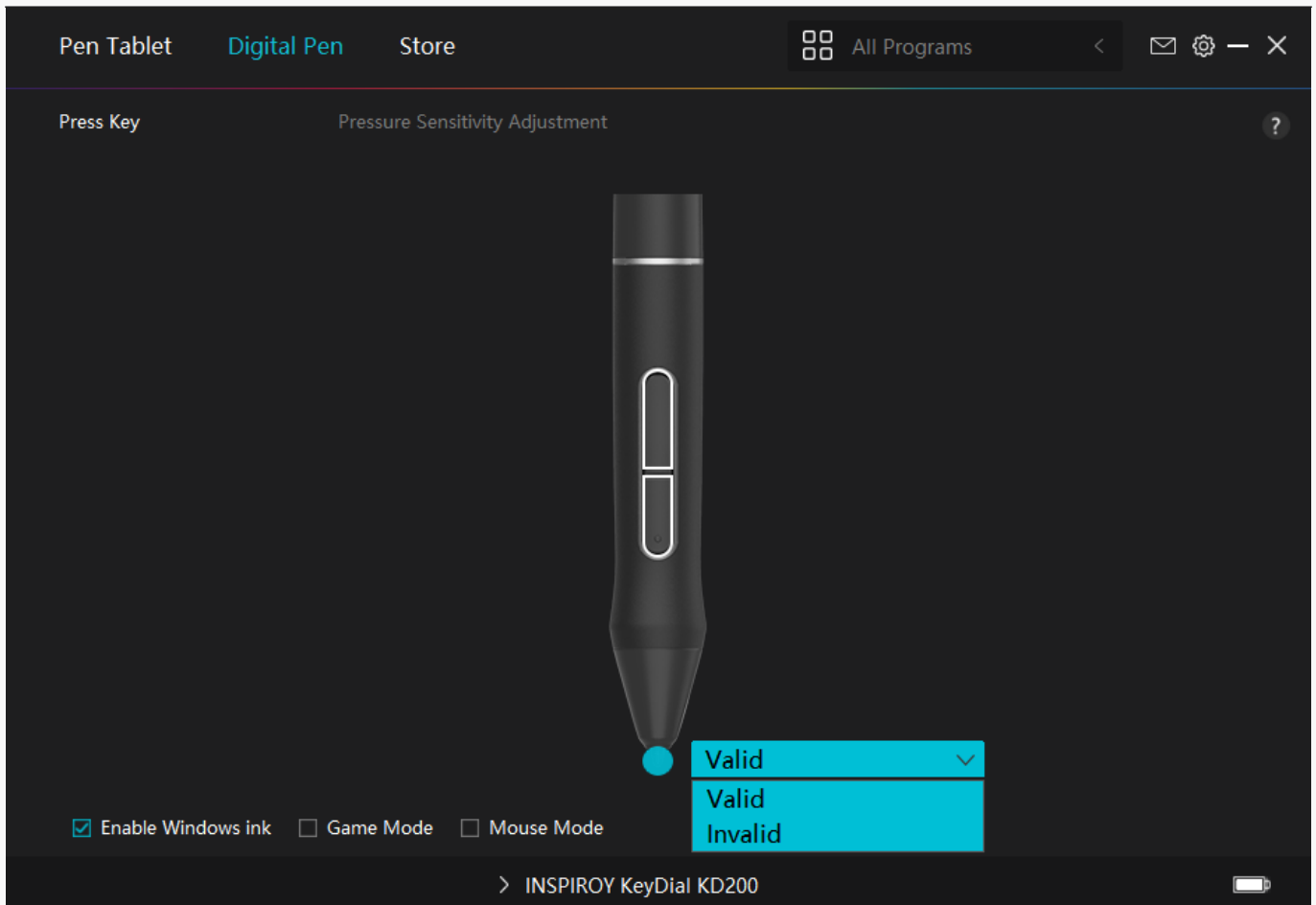

3. Enable Windows ink

Microsoft Windows provides extensive support for pen input. Pen features are supported in such as Microsoft Office, Windows Whiteboard, Adobe Photoshop CC, SketchBook 6 and so on.

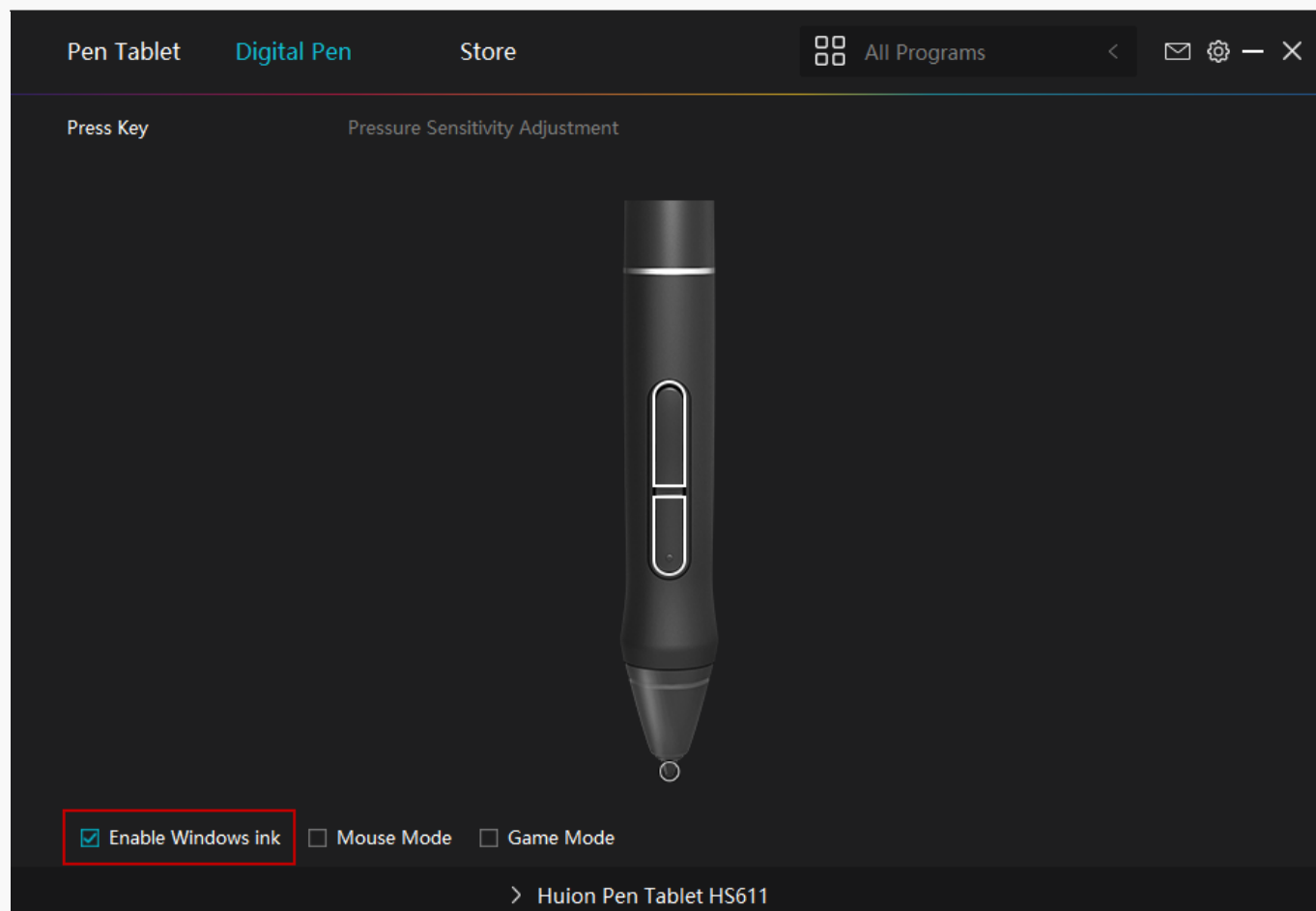

4. Mode Selection

Game Mode: This mode is specially designed for OSU games. OSU game users can turn on the "Game Mode" to increase the cursor's following speed when the pen nib moves quickly. It is not

recommended for non-OSU game users.

Mouse Mode: When the digital pen moves on the working area of the tablet, the "absolute coordinate" mode is adopted by default. After selecting the "mouse mode", it will change to the "relative coordinate" mode and you can use the digital pen like a mouse. With eight sensitivity levels to choose, you can also adjust the response speed of the digital pen according to your habits.

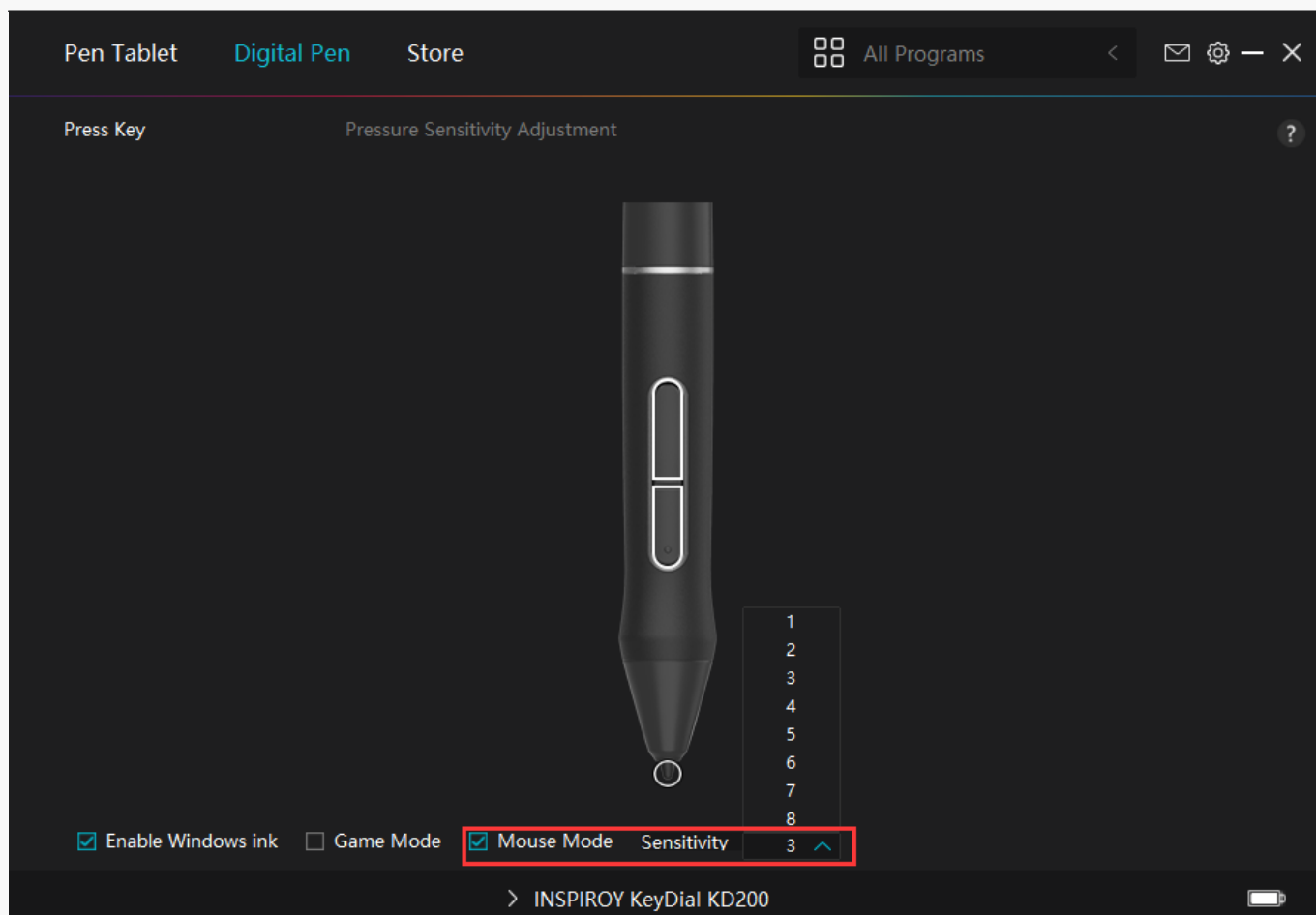

5. Pressure Sensitivity Adjustment

You can adjust the pressure sensitivity level by dragging the slider in the pressure factor setting box according to your usage habits. Click the redo button at the top right to revert to the default pressure.

(1) To decide the force required for a pen to produce a click or a pressure sensation.

(2) You can change the slope of the pressure response curve.

(3) To determine how much pressure needs to be applied to the pen nib to reach the highest pressure sensitivity level.

- Draw lines in the pressure test box with the pen, and the bar on the right will simultaneously show the pressure changes on the pen nib. Click the “Delete” button above to empty the lines, reset the pressure sensitivity level and test it until you find the appropriate pressure sensitivity level.
- A steep curve means a more sensitive response.

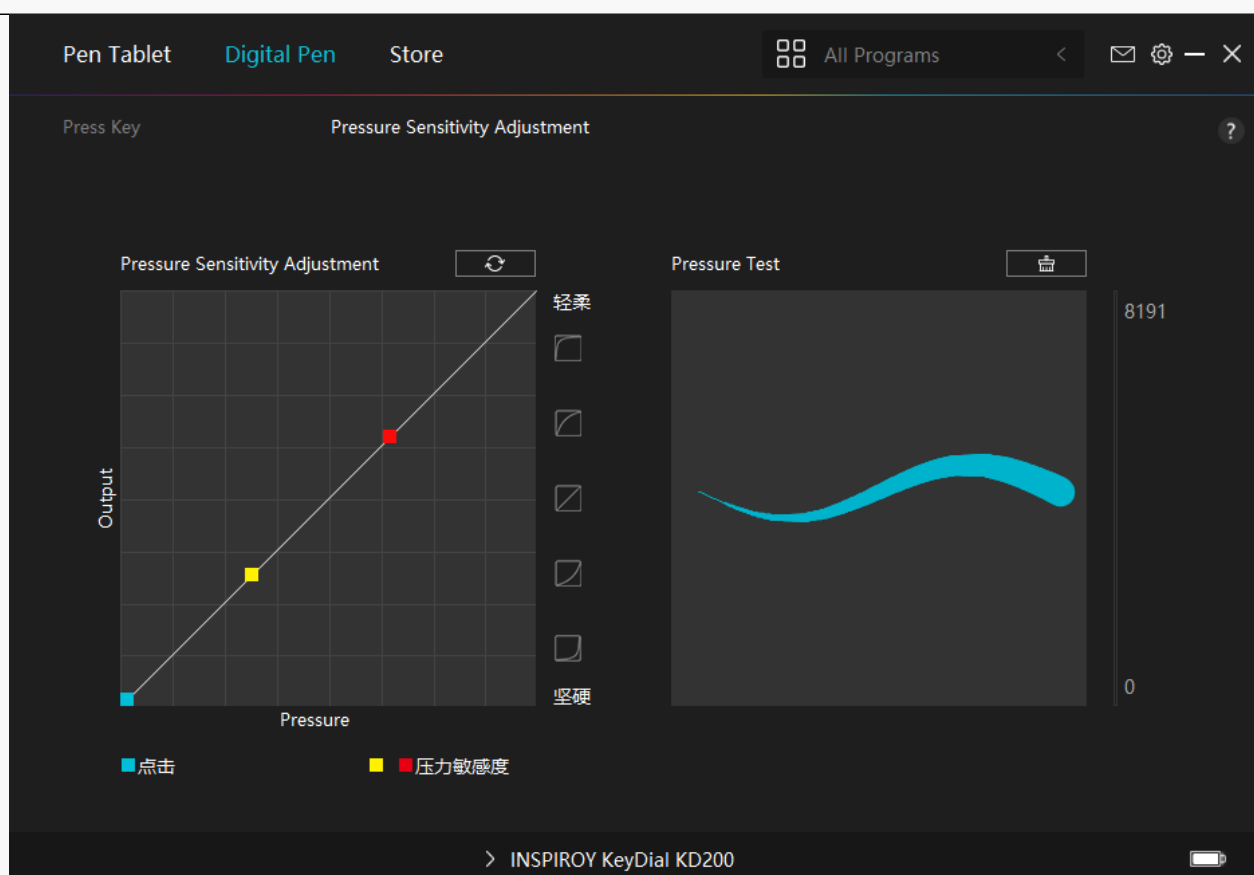

Driver Setting

1. Device

You can view the information of the firmware and the connected product here. Device Diagnosis [See Section](#).

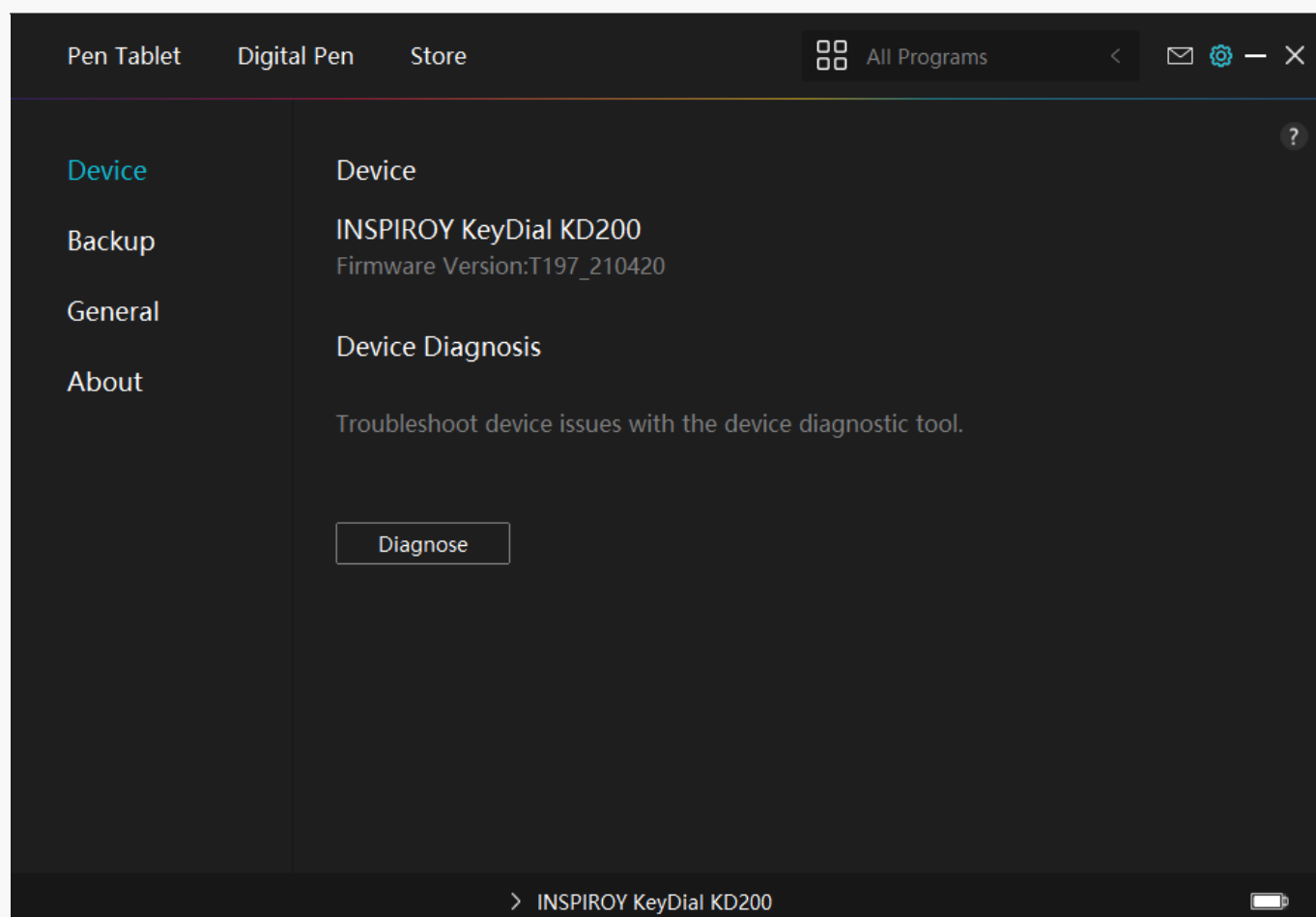

2. Backup

The Driver can import and export your custom settings, which helps to avoid repeated settings when launching a different program.

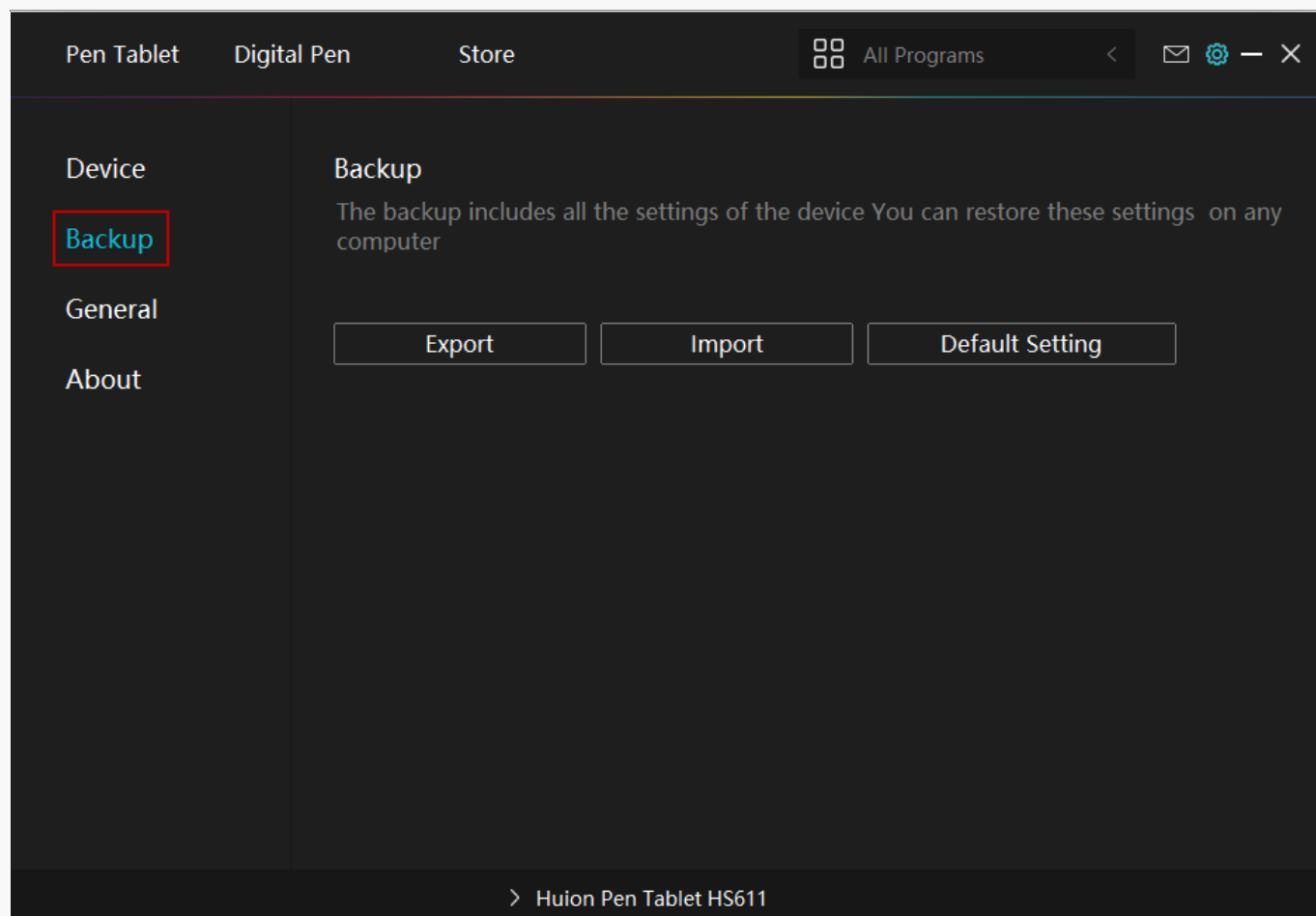

3. General Setting

[1] Language: Click the drop down menu to select a language.

[2] Color: You can select the color of the Driver interface among Dark, Blue, and Light according to your preference.

[3] Start Menu: Click to enable or disable AutoStart, New Message Alert, Automatic Updates.

[4] Hotkey: A hotkey can be used to call out the Driver interface quickly, you can set one according to your usage habits.

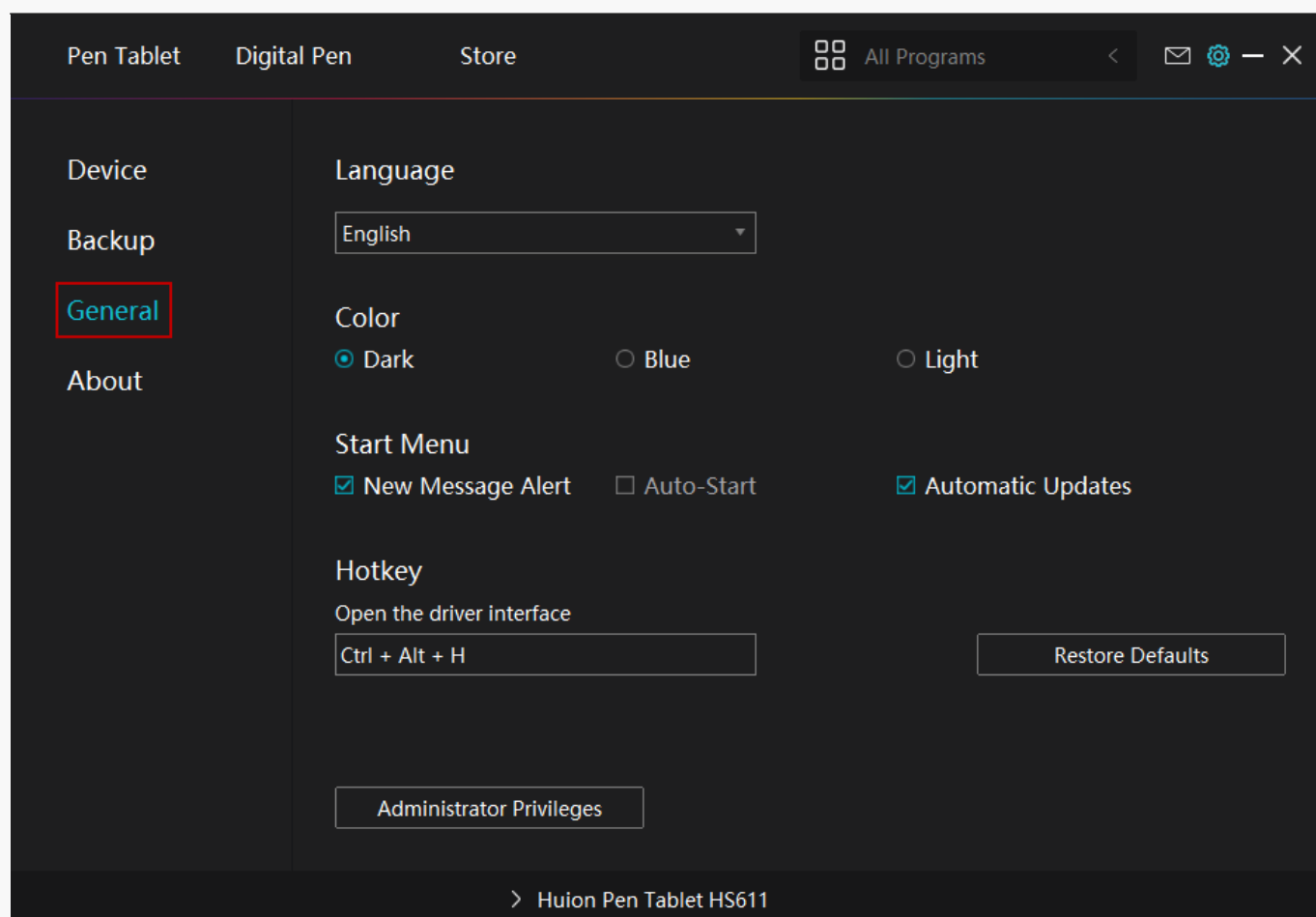

4. About

Users can check the Driver version number here. Click Check for Updates to view the latest Driver version and then follow the prompts to update the Driver if needed.

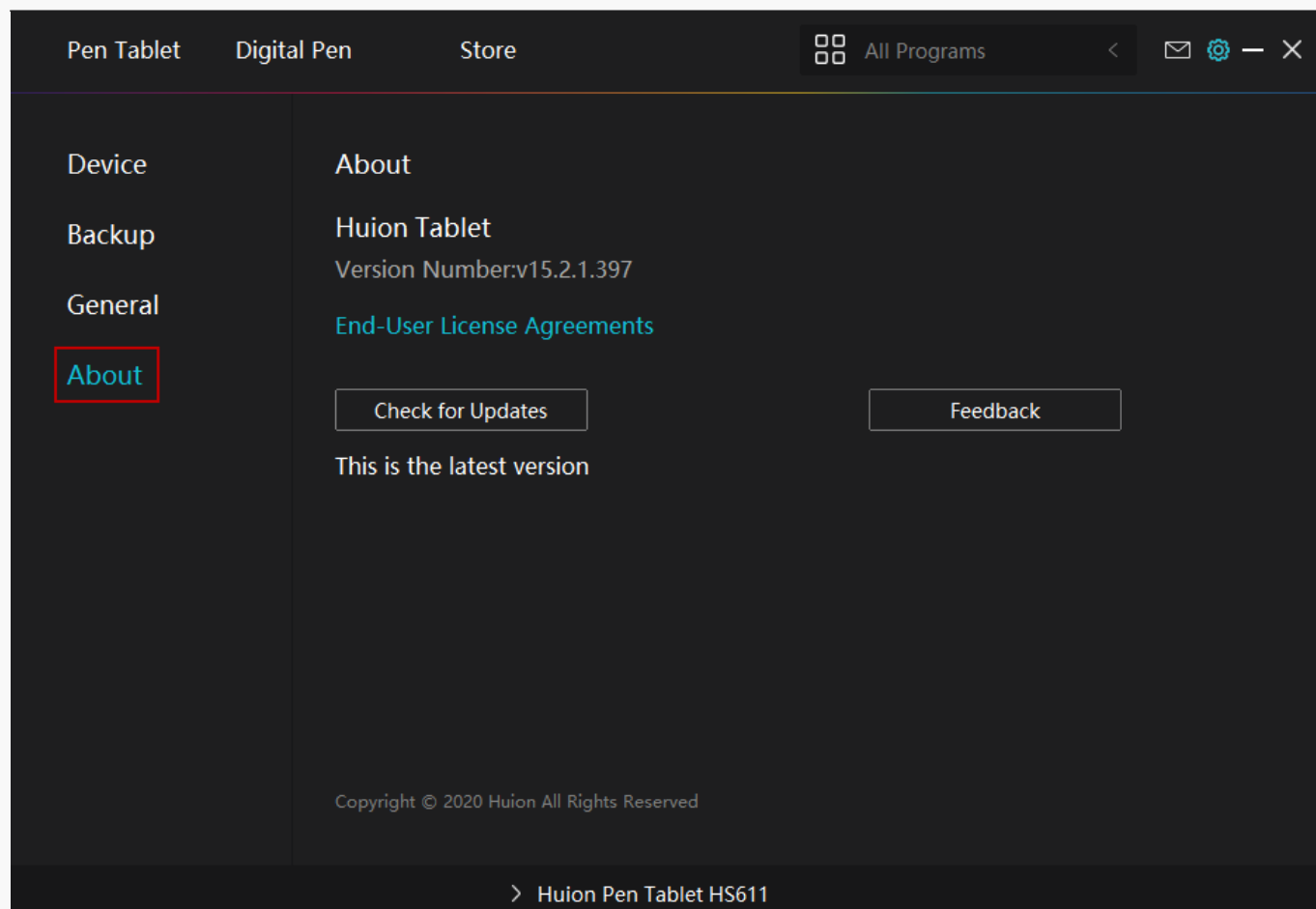

Diagnose

Press Key Test

1. Click "Diagnose", and select the device you want to test from the "Device Info"
2. Press these buttons one at a time to test them. Each time you press a key, its number will be displayed on the left next to the "Press Key".

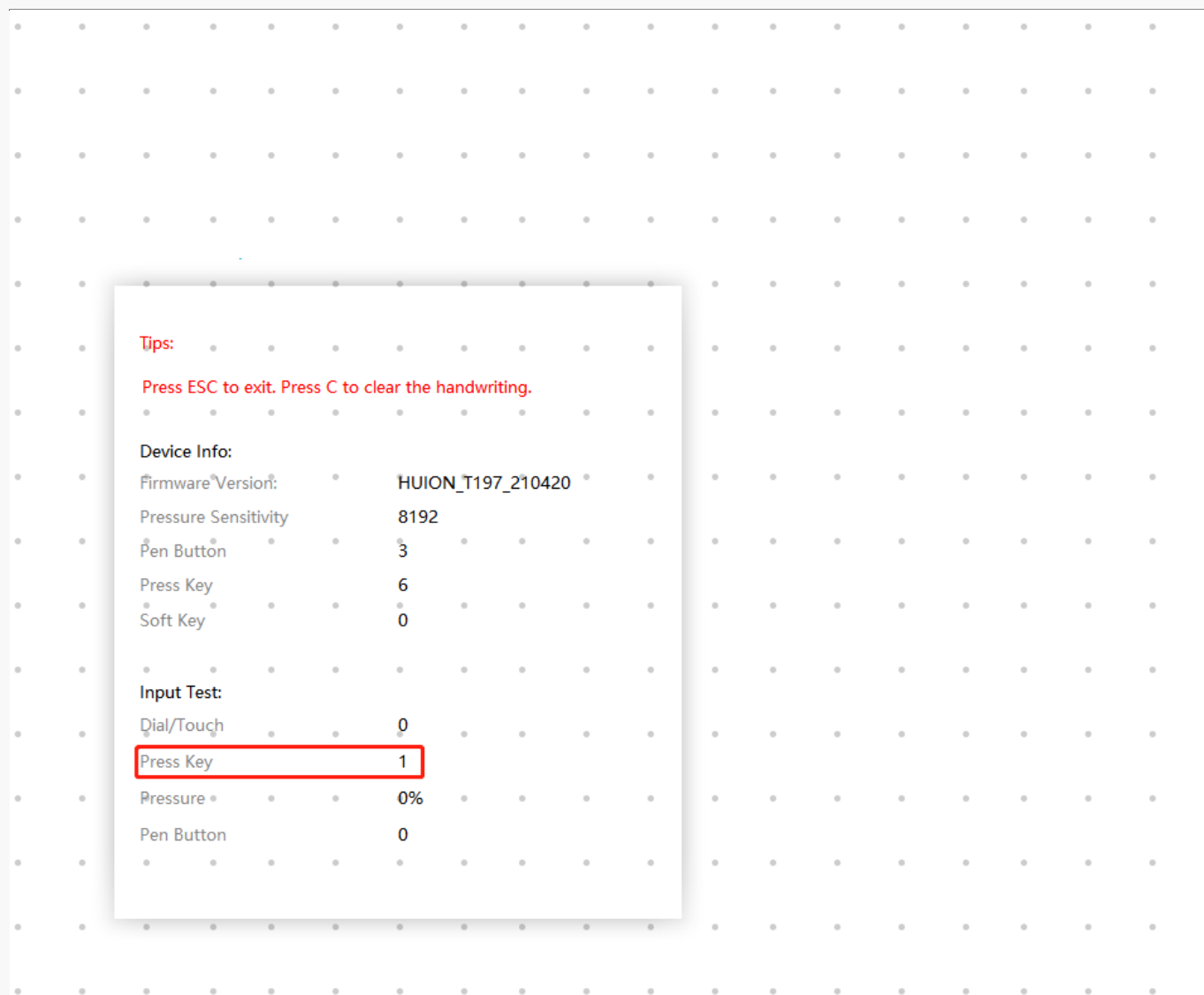

Pen Test

1. Click "Diagnose", you will see the below interface, hold the pen within 10mm (0.4 inches) from the surface of the tablet, and you will see relevant data appearing in the "Device Info". Move the pen across the surface of the tablet, and the pressure value will change accordingly.
2. Press the pen nib to the surface. When you press it with your maximum force, the pressure value should change from 0% to 100%.
3. Press the pen nib and pen press keys one at a time. When the pen nib does not touch the tablet, the "Pen Button" will show 0; when it touches, 1; when you press the down press key, 2; when you press the up press key, 3.

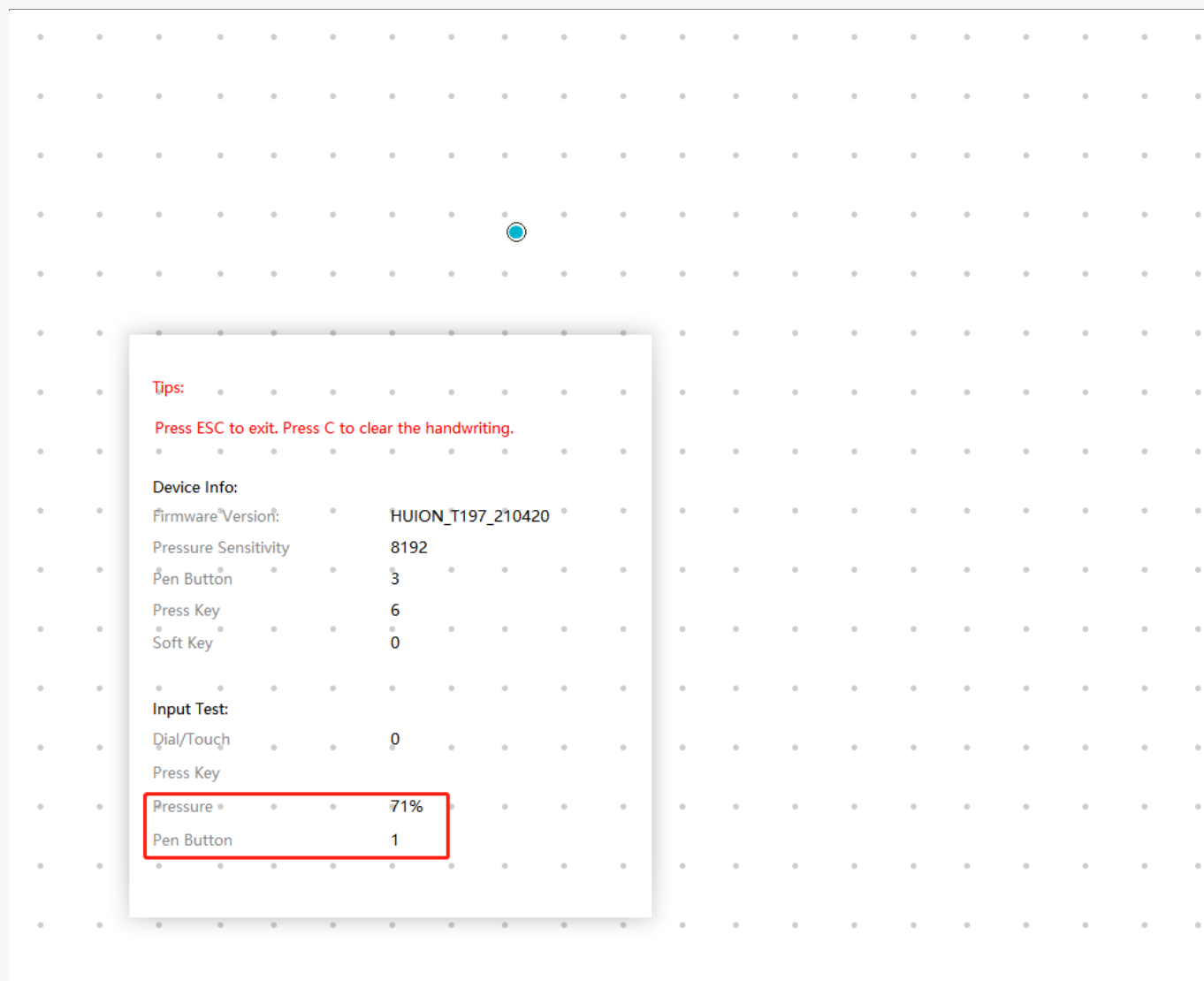

Touch Test

Note: If the basic touch functions (such as moving the cursor with your finger) can be used normally, while other touch- functions cannot, please reinstall the driver.

1. Move your finger on the surface of the tablet to move the cursor.
2. Touch a folder/program to select; tap twice to open it.
3. If your device has a status indicator light, when you touch the active area of the device, the indicator light should be on.

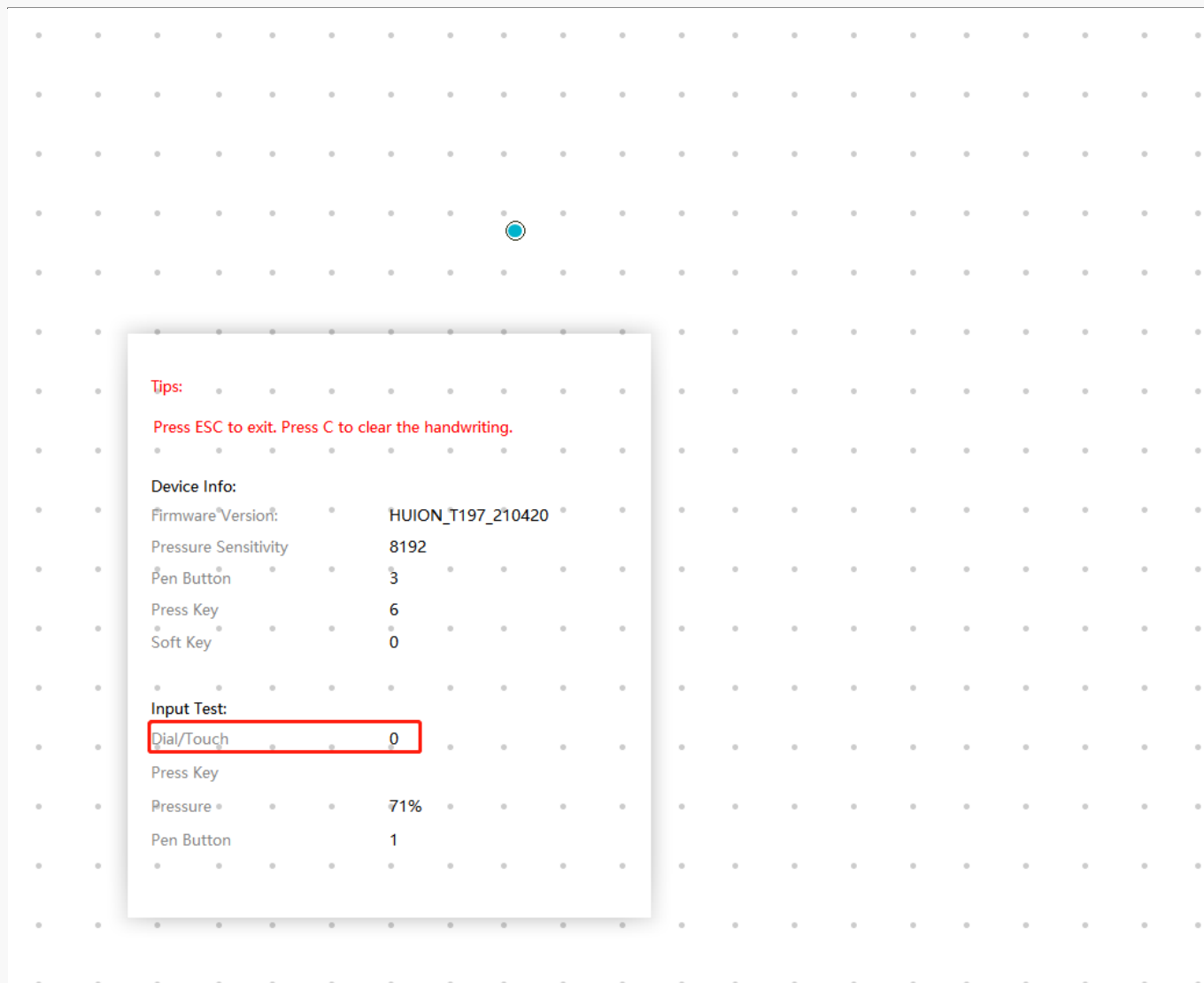

Dial Test

1. Click "Diagnose", and select the device you want to test.
2. Slide your finger along the side of the Dial, and check whether the "Dial/Touch" indicates the current movement of the finger on the Dial.

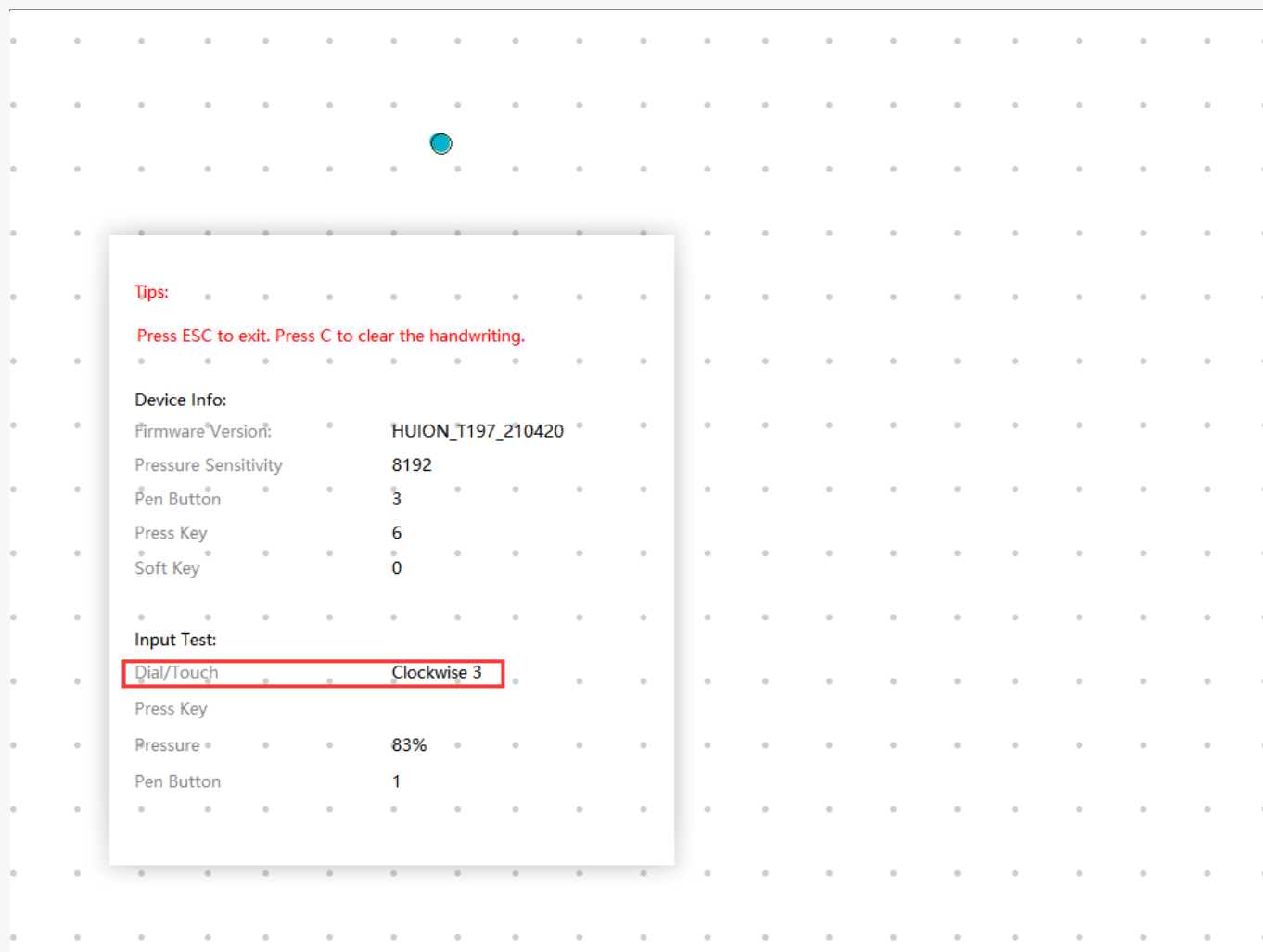

Digital Pen Basic Operation

Note: Picture shown is for illustration purposes only.

Hold the Pen

Hold the pen as you hold a normal pen or pencil. Adjust your grip so that you can toggle the side switch easily with your thumb or forefinger. Be careful not to accidentally press the switch while drawing or positioning with the pen.

Note:

When not in use, place the pen in the pen case or on the desk. Do not place the pen on the surface of screen, which may interfere with the use of other screen cursor positioning equipment, may also cause your computer can not enter the sleep mode.

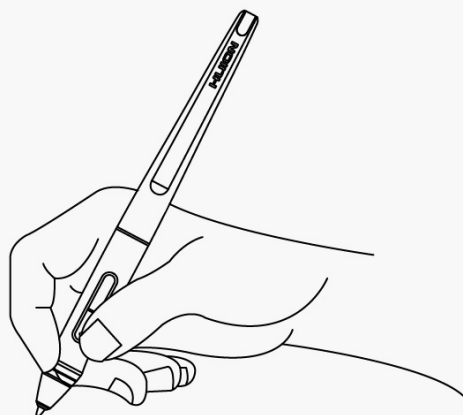

Position the cursor

Move the pen slightly above the active area without touching the screen surface, the cursor will move to the new position accordingly.

Press the pen tip on the screen to make a selection. Tap the screen once with the pen tip, or touch it to the screen with enough pressure to register a click.

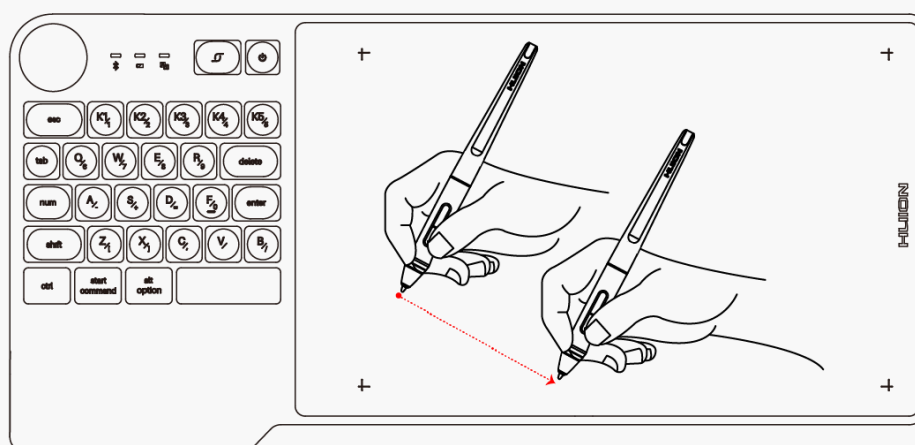

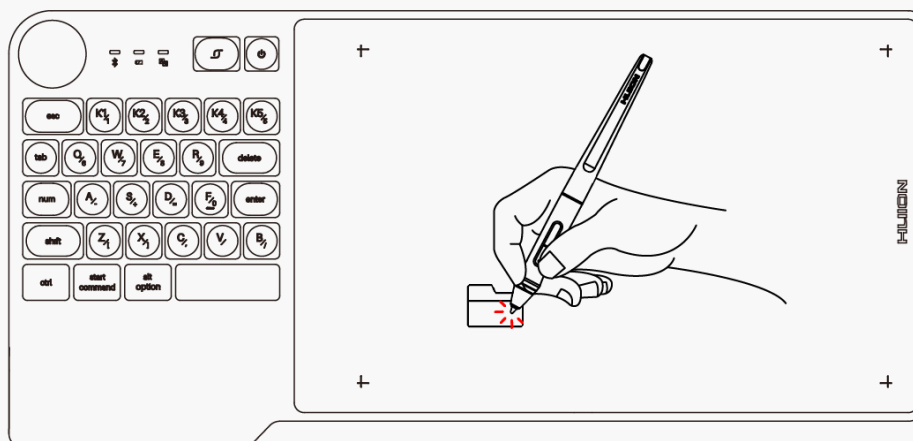

Click

Use the pen tip to tap once on the screen to register a click. Tap to highlight or select an item on the screen and double-click to open it.

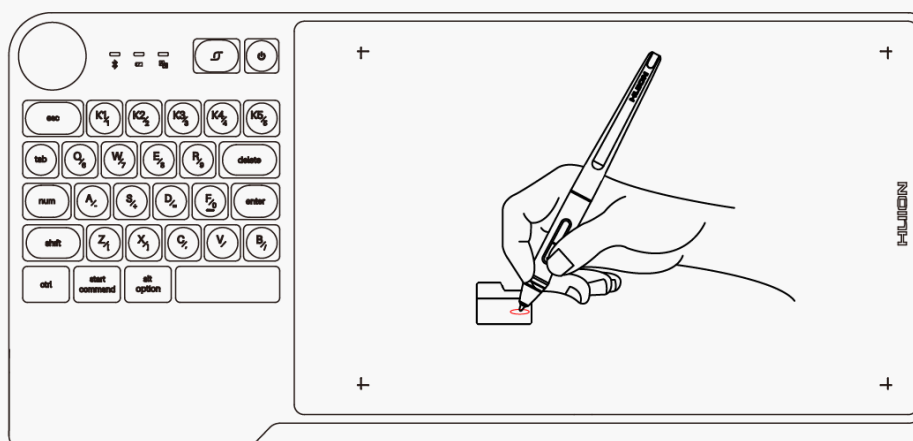

Move

Select the object, then slide the pen tip across the screen to move it.

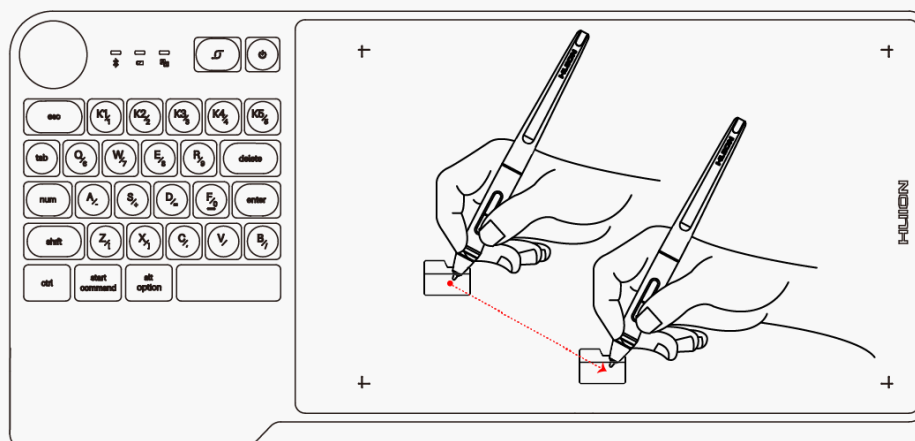

Use the side buttons

The buttons on the pen can be set to two different customizable functions. You can use the buttons whenever the pen tip is within 10mm of the tablet active area. You do not have to touch the pen tip to the tablet in order to use the switch.

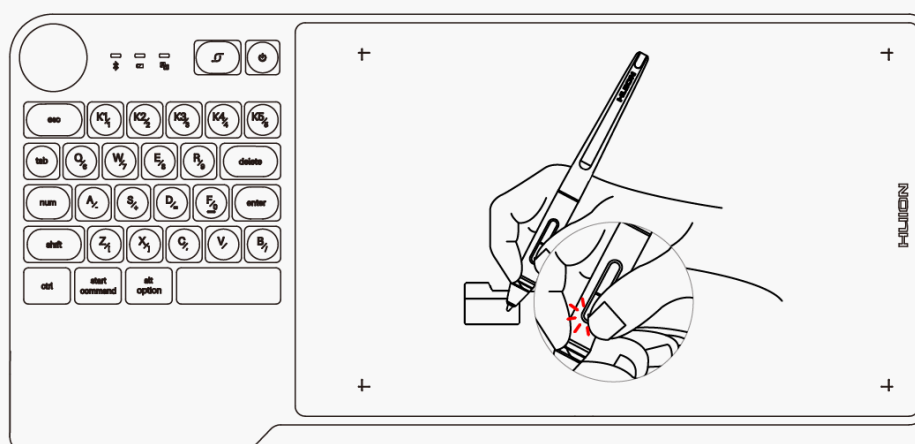

Pen Nib Replacement

The nib will be wear off after using for a long time, then you need to replace a new nib.

1. Anticlockwise rotate the pen holder to open the cover, take a new nib out.
2. Insert the pen nib into the pen nib clip and tilt the pen to pull out the old nib.
3. Insert the new nib straight into the pen and push the nib slowly and firmly until it stops.

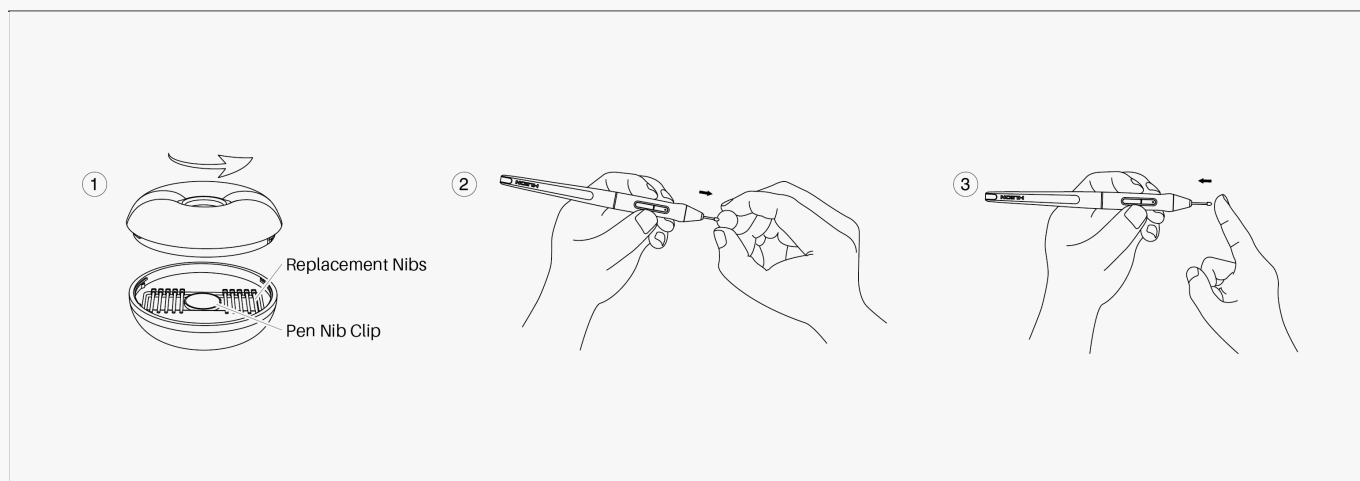

Specifications

Here are the product specifications for you to learn more about the Tablet. If you have any questions, please feel free to contact us.

The following data will vary in different usage environments and are for reference only.

Appearance

Color:	Metal Grey
Dimension:	394.5 × 187.7 × 8.5mm
Workspace:	226 x 142.88mm
Net Weight:	650g
Interface:	USB-C

Technical Specifications

Digital Pen:	PW517
Pen Technology:	Battery-Free Electromagnetic Resonance
Pen Resolution:	5080 LPI

Pressure Sensitivity:	8192 Levels
Tilt Support:	±60°
Sensing Height:	10mm
Report Rate:	> 233PPS
Accuracy:	±0.3mm
Press Keys: Press Keys+Dial	23 Standard keys+5 Programmable

OS Compatibility

Windows 7 or later
macOS 10.12 or later
Android 6.0 or later

Troubleshooting Solutions

There is no pressure in the graphics software but the cursor moves.

You may have installed other tablet drivers or opened the drawing software when installing the driver. Please uninstall all drivers and close the drawing software, then reinstall the Huion driver. It's better to restart your computer after finishing the installation.

The pen does not work.

1. Make sure you are using the pen that originally came with your tablet.
2. Make sure you installed the driver correctly.

Press Keys does not work.

1. Make sure the Press Keys function were enabled in the driver.
2. Make sure you have correctly defined the Press Keys.
3. Check if the press lock switch is on the unlock position.

The side button of the pen doesn't work.

When pressing the side button, please make sure that the nib didn't touch the tablet surface and the distance between the nib and surface is within 10mm.

If your problem is not resolved, please click [FAQs](#) to view more troubleshooting methods or email us (service@huion.com).